

A detailed 3D architectural rendering of an industrial plant, likely a refinery or chemical processing facility. The image shows a dense network of pipes, tanks, and structural steel beams. The color palette is dominated by shades of blue, grey, and white, with some yellow and red highlights. The perspective is from a low angle, looking up at the complex structure.

***DINAMIK PROJE  
ENGINEERING AND CONSULTING LTD. CO.***

***COMPANY PROFILE AND  
REFERENCE LIST***

***2021***

## **CONTENTS**

<b>ABOUT US</b> .....	3
<b>ORGANIZATION CHART</b> .....	4
<b>SERVICES OF THE COMPANY</b> .....	4
<b>DESIGN SERVICES AND SYSTEMS</b> .....	5
<b>SPECIFIC SYSTEMS</b> .....	6
<b>AVAILABLE DESIGN OR CALCULATION SOFTWARES</b> .....	7
<b>SOME OF THE PROJECTS COMPLETED BY THE FOUNDERS OF DINAMIK PROJE AND THEIR TECHNICAL TEAM MEMBERS AT THE PREVIOUS COMPANY</b> .....	8
<b>INTERNATIONAL EXPERIENCE</b> .....	9
<b>SOME OF THE DESIGN STUDIES BY REVIT</b> .....	10
<b>DINAMIK PROJE</b> .....	15
<b>SOME PROJECT REFERENCES</b> .....	15
<b>Public Transportation Buildings, Airport Terminals and</b> .....	16
<b>Train Stations</b> .....	16
<b>Health Care Building Projects</b> .....	26
<b>Shopping Malls and Retail Building Projects</b> .....	32
<b>Office Building Projects</b> .....	44
<b>Industrial Facilities Projects</b> .....	61
<b>Residential Building Projects</b> .....	82
<b>Cultural and Educational Building Projects</b> .....	94
<b>Hotel and Holiday Village Projects</b> .....	102
<b>Stadium and Sport Complexes</b> .....	115
<b>CO – Generation &amp; Power Plants</b> .....	116
<b>Some of Building with Yamata Inc.</b> .....	118
<b>CURRENT PROJECTS</b> .....	119
<b>CONTACT US</b> .....	121

## ABOUT US

Dinamik Proje,

Provides project and consultancy services for the facilities indicated in the design services section of our web site and on the subjects regarding Building Mechanical Installation. It has taken place in important projects, only some of which we have listed in the Projects section of our website, and it continues to do so both in Turkey and in the countries, we have indicated in the Company profile section of our website.

We have conducted works with reputable architecture and mechanical consulting groups regarding their productions, and these works are going on. Besides, we are one of the most important engineering groups that is very successful in and out of Turkey and which supports Turkish contracting companies. In parallel to our developments in our technological sub-investments, our support to contracting companies increasingly continues. We would like to share some of the main reasons of our achievements with you.

All of the founders and employees of Dinamik Proje, without exception, worked under the umbrella of Dinamik Proje, or together under the umbrella of their previous company, Gürdal Mühendislik, which is one of the main reasons for Dinamik Proje to exist, after having completed their education or military service. Also, we have established sister companies whose names are Dinamik Proje Enerji, Sinerji Dinamik Proje and Vektör Dinamik Proje.

Dinamik Proje has been continuing without interruption for 32 years. We succeeded in retiring some of our friends in this association and we are so much proud of it. However, our association with them still continues and they maintain their efforts to transfer the experiences that they had obtained in years to our younger friends with a huge endeavor. More than half of our employees have an experience of working together between 10 and 25 years. This is both one of the sources of pride of our company and one of the vital reasons behind our achievements. One of the most important sources of Dinamik Proje is its solid endeavor in following the latest technologies around the world.

For example; We are one of the first users of the Autodesk MEP and REVIT program, except USA and United Kingdom, that enables three-dimensional design, maybe we are the first. When the program could not achieve the stage to provide mass education, meaning that when it was on trial, the intense demand from Dinamik Proje was supported by Autodesk and the wale was made. In every means we experience the results contributed to our project by this support. We express our gratitude towards Autodesk for this great support they provided to us. In summary, whatever endeavor the most developed project groups around the world are exerting, Dinamik Proje maintains the same endeavor in parallel.

We would like to end the introduction of our company with a humor. The logo of the Dinamik Proje is not a copy of BMW, which we admire and is one of the technological wonders of its own industry, and besides, its filling directions are different. Filled part on the left bottom represents the letter d, filled part on right above represent the letter p. in other words Dinamik Proje. Moreover, this figure can be used for grade indication in construction industry or as hydrant indication in mechanical installation, which means that it is also a symbol that reminds of our industry.

## ORGANIZATION CHART

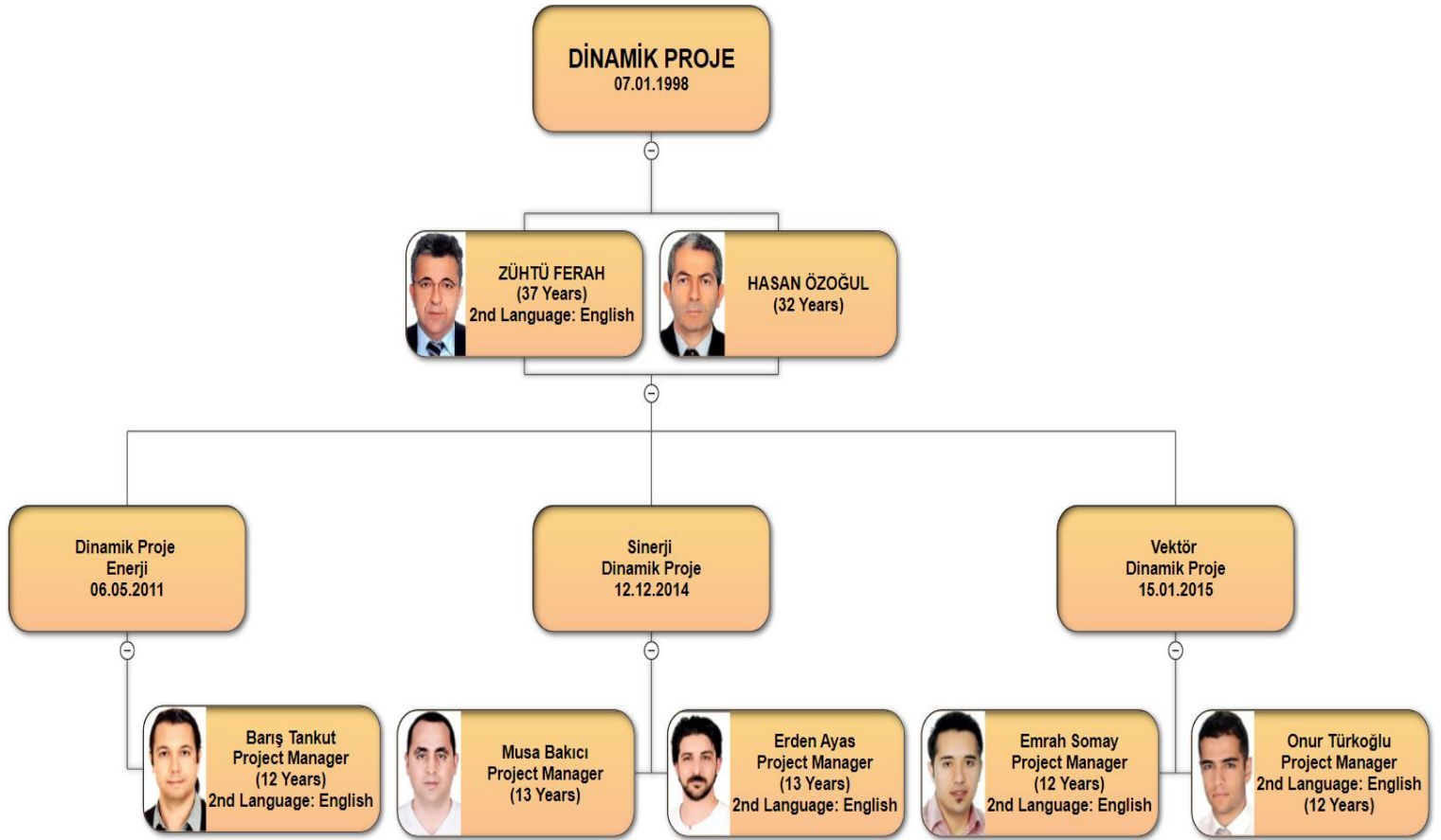

### Technical Personnel

- ✓ Mechanical Engineer: **25** Person
- ✓ Energy Systems Engineer: **1** Person
- ✓ Technical Draftsman: **32** Person
- ✓ Accounting, IT and Service Personnel: **9** Person

---

**TOTAL** **67** Person

We've been working with more than 50% of our staff for approximately ten to thirty years.

## SERVICES OF THE COMPANY









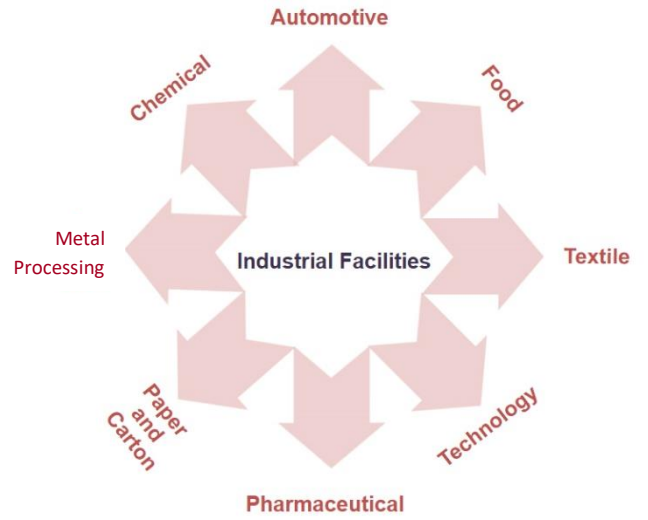
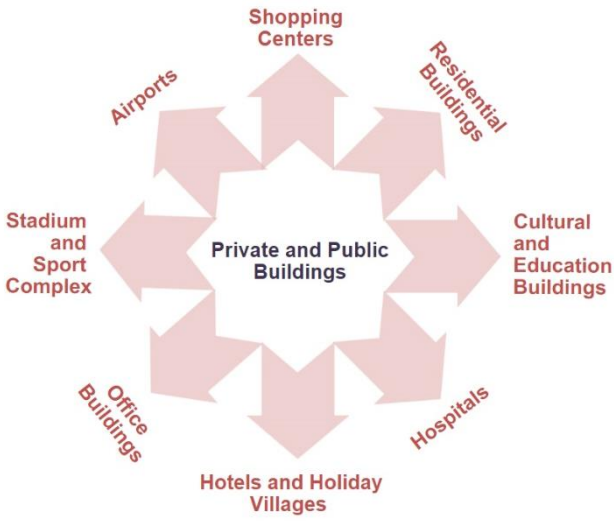







Design and consultancy services for mechanical installation works;

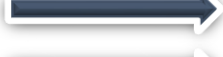
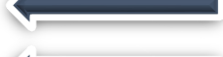
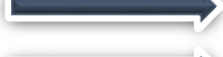
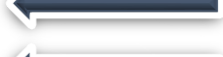
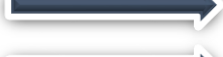
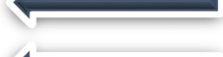
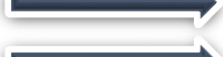







# DESIGN SERVICES AND SYSTEMS

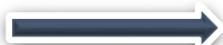

- |  |  |                              |   |
|--|--|------------------------------|---|
|  | <b>HVAC</b>                                    | <b>STEAM</b>                 |  |
|  | <b>FIRE FIGHTING</b>                           | <b>SUPERHEATED WATER</b>     |  |
|  | <b>SMOKE EXHAUST AND POSITIVE PRESSURIZING</b> | <b>HIGH TEMPERATURE OIL</b>  |  |
|  | <b>SANITARY AND PLUMBING</b>                   | <b>COMPRESSED AIR</b>        |  |
|  | <b>RAIN WATER DRAINAGE</b>                     | <b>PROCESS LINE</b>          |  |
|  | <b>IRRIGATION</b>                              | <b>HEATING – COOLING</b>     |  |
|  | <b>POOL FILTRATION, FOUNTAIN AND SAUNA</b>     | <b>VENTILATION – EXHAUST</b> |  |
|  | <b>TREATMENT</b>                               | <b>HOT AND COLD WATER</b>    |  |
|  | <b>GREY WATER RECOVERY</b>                     | <b>DRAINAGE</b>              |  |
|  | <b>HEAT RECOVERY</b>                           | <b>HEAT RECOVERY</b>         |  |
|  | <b>CO-GEN AND THREE-GEN</b>                    | <b>WATER RECOVERY</b>        |  |
|  | <b>CENTRAL VACUUM CLEANING AND WASTE</b>       |                              |   |

## SPECIFIC SYSTEMS

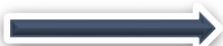
-  HEATING AND COOLING SYSTEMS  
USING GAS TURBINE OR  
GAS MOTOR REMAIN ENERGY  
(CO-GEN OR THREE-GEN SYSTEMS)
-  WATER, SOIL OR AIR SOURCE HEAT PUMP
-  SOLAR OR THERMAL ENERGY SOURCE  
HEATING AND COOLING
-  HOT WATER, HIGH TEMPERATURE WATER AND STEAM BOILER HOUSES  
WORKING WITH GAS, FUEL OIL,  
DIESEL OIL OR COAL
-  DISTRICT HEATING AND COOLING
-  COLD STORAGEES

## AVAILABLE DESIGN OR CALCULATION SOFTWARES



**Revit MEP 2020**  
(Autodesk)



**AutoCAD MEP 2020**  
(Autodesk)



**AutoCAD 2020**  
(Autodesk)



**MagiCAD**  
(Autocad MEP base)



**MagiCAD**  
(Revit MEP base)  
Pressure Loss  
Sound Acoustic

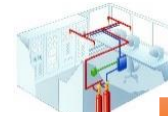

**OmniCADD**  
(Hydraulic Calculation software)  
for Fire Fighting Systems



**Linear Heat Load 20**

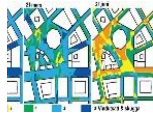

**3D Mikroklimat**

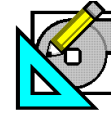

Hourly Analysis Program  
**(HAP 5.0i - Carrier)**  
for Cooling Load Calculation

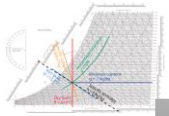

**HDPsyChart**  
(Hands Down Software)  
Psychrometric Analysis



**Kesa Aladin**



**IZODER TS825**



**Dynamo**

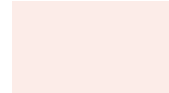

**SmartPlant**

## SOME OF THE PROJECTS COMPLETED BY THE FOUNDERS OF DINAMIK PROJE AND THEIR TECHNICAL TEAM MEMBERS AT THE PREVIOUS COMPANY

- ✓ Kirklareli Sise Cam Factory - Kirklareli - Turkey
- ✓ Edirne Cumhuriyet Cooperative - Edirne – Turkey
- ✓ Bati (West) Tourism, Trade & Entertainment Center - Buyukcekmece (Tatilya) - Turkey
- ✓ Ataturk Airport New Terminal Buildings - Istanbul - Turkey
- ✓ THY Data Processing Center
- ✓ Zhezkazgan Hospital Complex - Kazakhstan
- ✓ President House of Turkey - Kalender - Istanbul - Turkey
- ✓ Mc Donald's Restaurants - Istanbul - Izmir - Izmit - Ankara - Turkey
- ✓ Holiday Inn Hotels - Istanbul - Turkey
- ✓ Otosan Automotive Factory - Eskisehir - Turkey
- ✓ Otosan Automotive Factory - Istanbul - Turkey
- ✓ Toprak Iron Foundry Industry Company - Bozuyuk - Turkey
- ✓ Kent Eveready Battery Factory - Gebze - Turkey
- ✓ Kent Food Products Manufacturer Inc. - Istanbul - Turkey
- ✓ Assir WTF - Saudi Arabia
- ✓ Hapimag Resort - Bodrum ( Sea Garden ) - Turkey
- ✓ Laguna Hotel - Marmaris - Turkey
- ✓ New Celik Palace Hotel and Congress Center - Bursa - Turkey
- ✓ Lykia World / Robinson Club - Fethiye - Turkey
- ✓ Asteria Hotel - Antalya - Turkey
- ✓ Mega Palace - Belek - Antalya - Turkey
- ✓ Palmiye Hotel - Kemer - Antalya - Turkey
- ✓ Marmara Plaza - Istanbul - Turkey
- ✓ Atakoy Marine Buildings - Istanbul - Turkey
- ✓ Holiday Inn Crown Plaza - Istanbul - Turkey
- ✓ Eryaman Organized Public House Complex - Ankara - Turkey
- ✓ Milnas Organized Public House Complex - Istanbul - Turkey
- ✓ Business Center Tverskaya, 16/2 Moscow - Russia
- ✓ Adler Branch of "Kubanbank" Sochi - Russia
- ✓ Toprak Center - Yildiz - Turkey
- ✓ Ceylan Intercontinental Hotel - Antalya - Turkey
- ✓ Russky Capital - Moscow - Russia
- ✓ Inco Business Center - Istanbul - Turkey
- ✓ Alarko - Maslak Business Center - Istanbul - Turkey
- ✓ Hyundai Automotive Factory - Izmit - Turkey
- ✓ Tisk Microsurgery Hospital - Istanbul - Turkey
- ✓ Perissia Hotel - Side Antalya - Turkey
- ✓ Perissia Hotel - Urgup - Turkey
- ✓ Club Adora - Antalya - Turkey
- ✓ Club Colessia - Pamukkale - Turkey
- ✓ Dinatex Blue Jean Factory - Corlu - Turkey
- ✓ Mavi Jean Factory - Corlu - Turkey
- ✓ Denimko Blue Jean Factory - Corlu - Turkey
- ✓ Motor Jeans - Corlu - Turkey
- ✓ ATK Textile Factory - Cerkezko - Turkey
- ✓ Cimas Textile Factory - Zonguldak - Turkey
- ✓ Otosan - Istanbul Service + Show Room - Istanbul - Turkey
- ✓ Tofas - Suroto Service + Show Room - Beylikduzu - Turkey
- ✓ Otosan - Car Motor Service + Show Room - Antalya - Turkey



## INTERNATIONAL EXPERIENCE

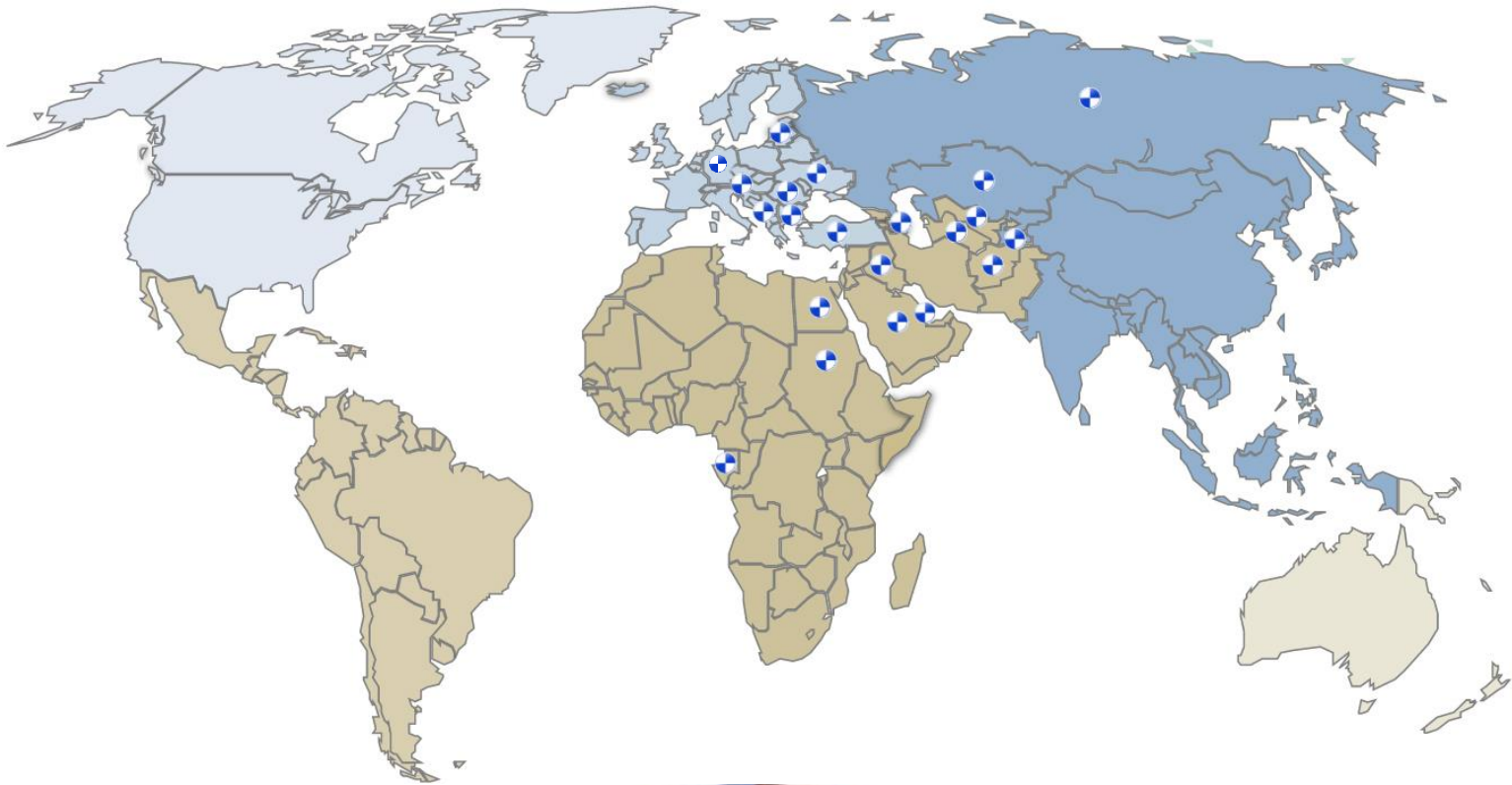



## SOME OF THE DESIGN STUDIES BY REVIT

- ✓ Unilever Vector Factory Facility (Cooling and Heating Center)

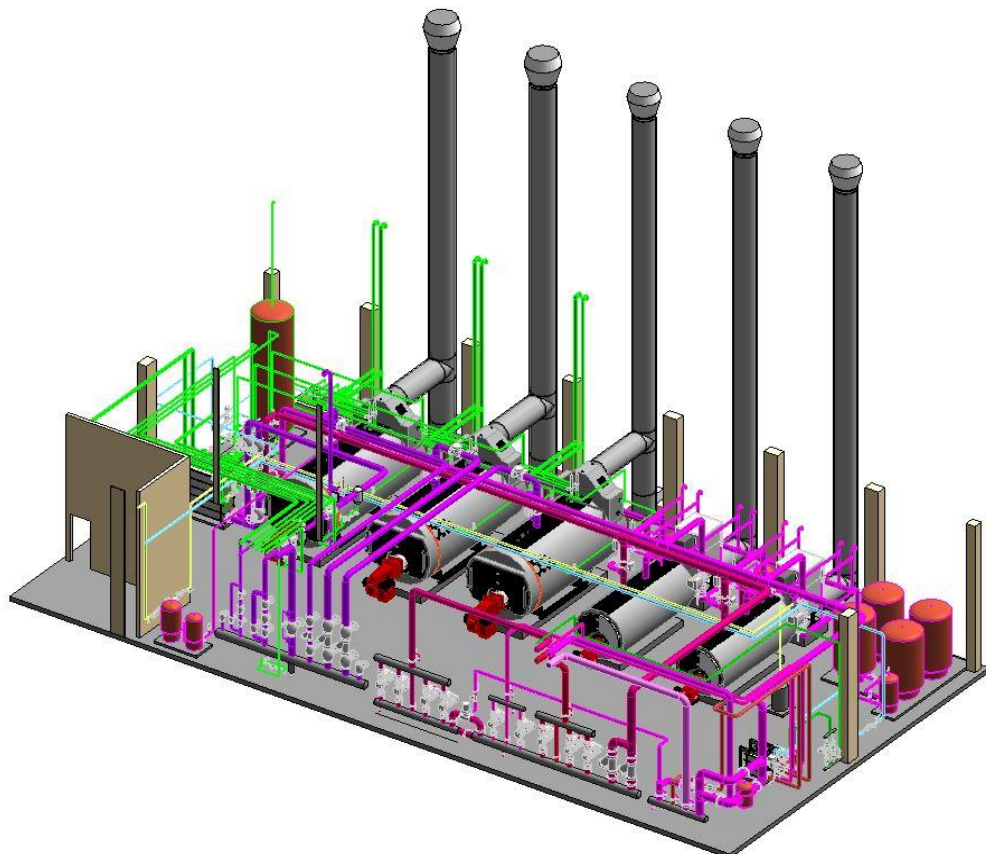
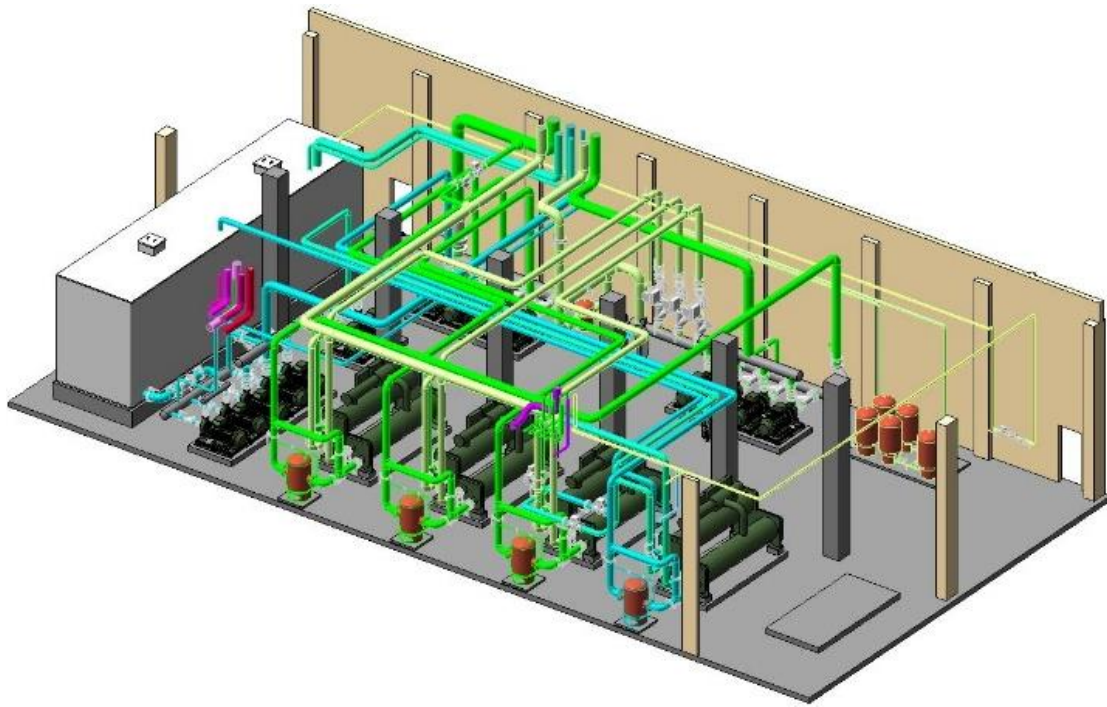

✓ **Kashirskaya Multifunctional Shopping Center  
(Domestic Water Pump and Cooling Tower Room)**

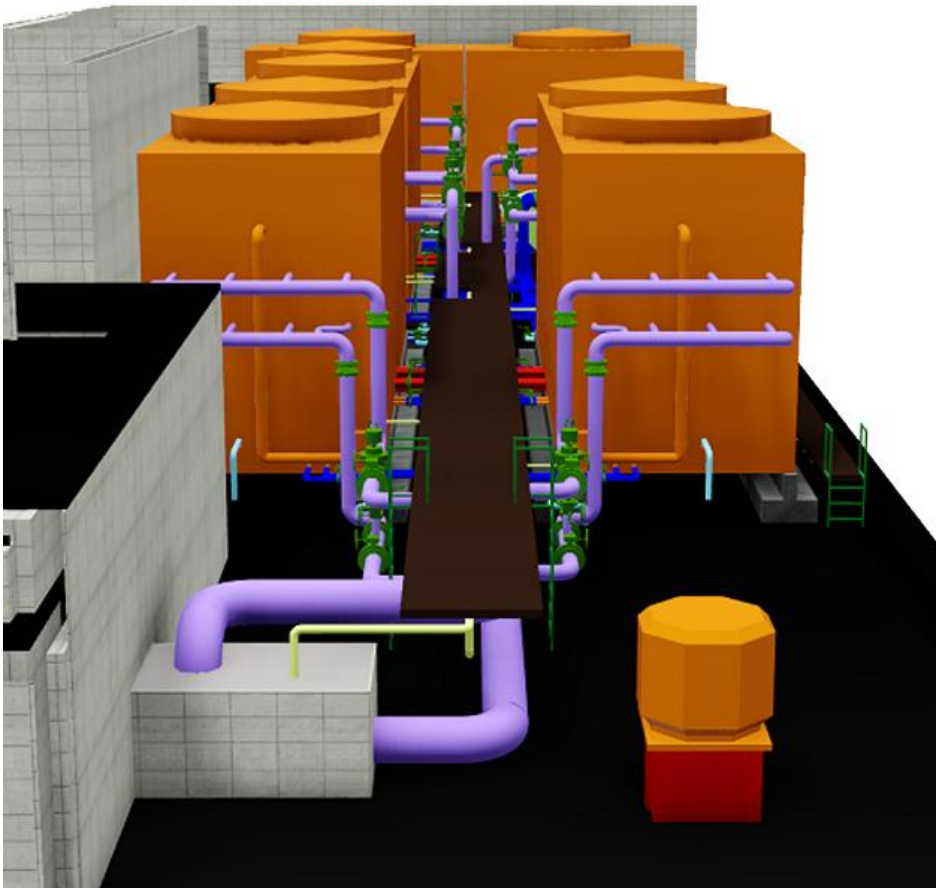
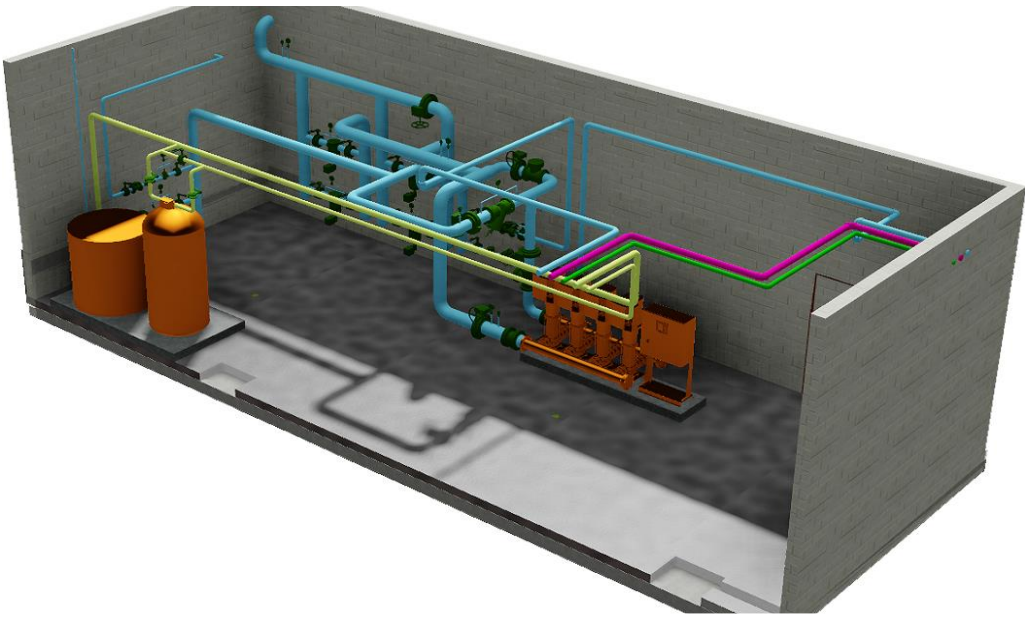

✓ **InIstanbul Residence  
(Fire Pump Room)**

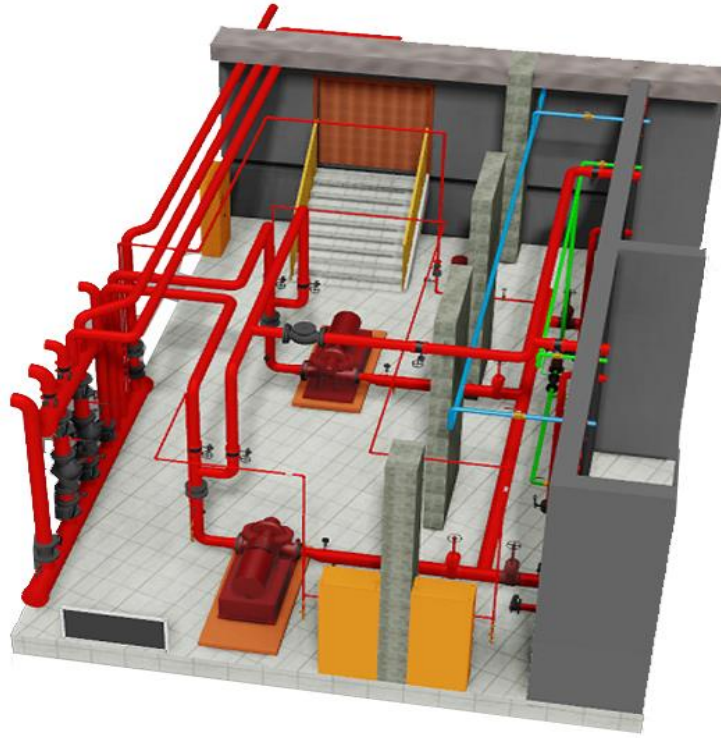

✓ **Nef Kandilli Residence  
(Heating Center)**

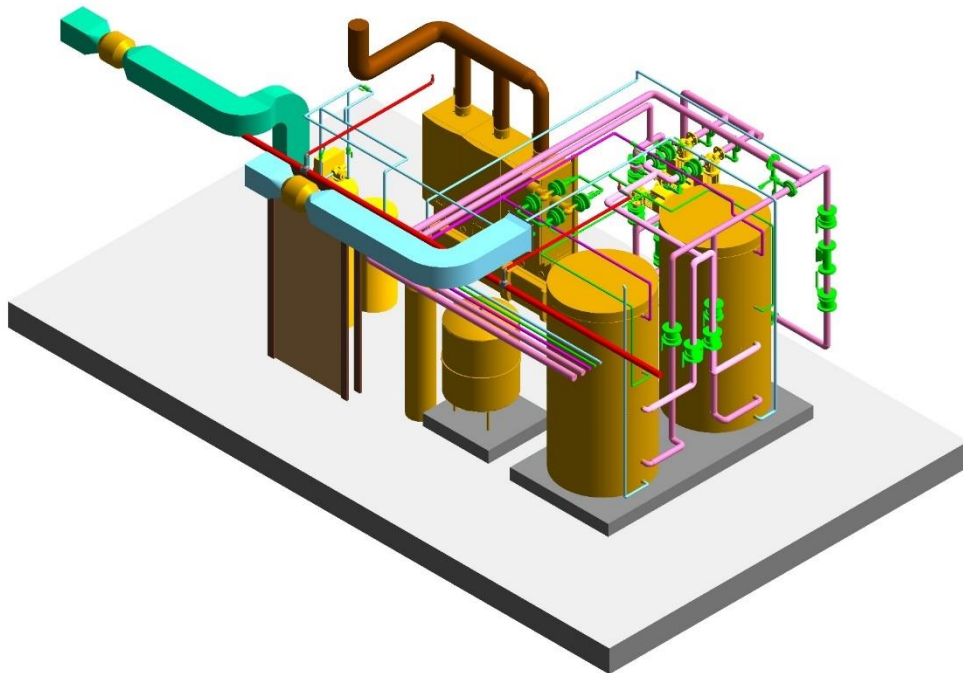



✓ **Medipol Mega University Hospital  
(Patient Room)**

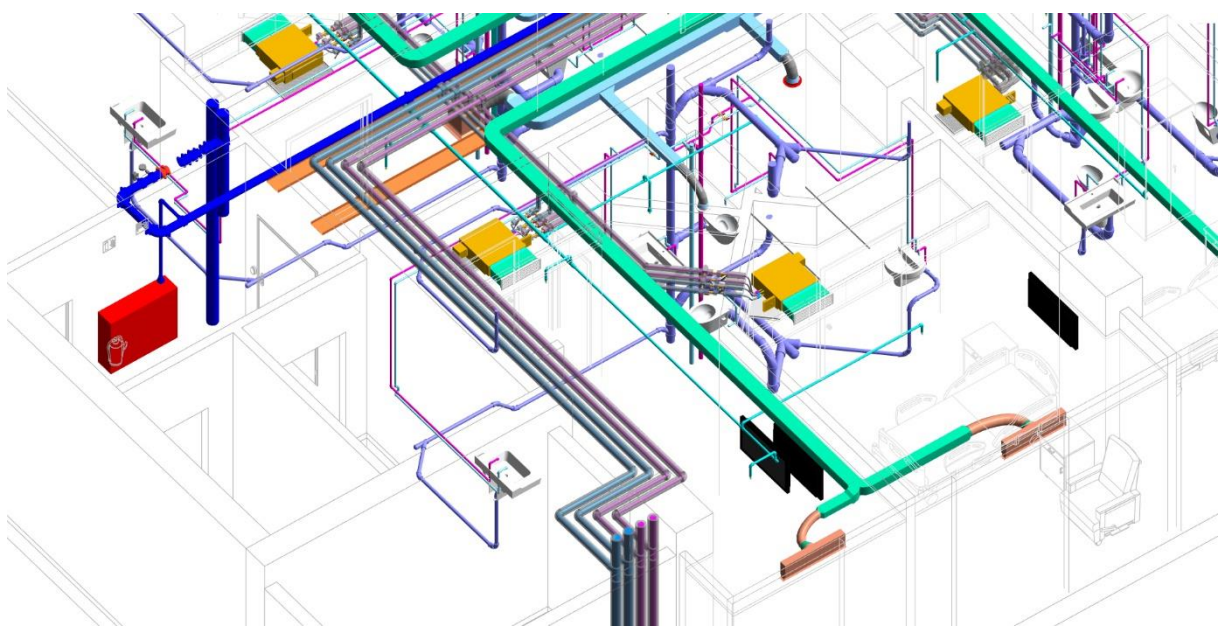
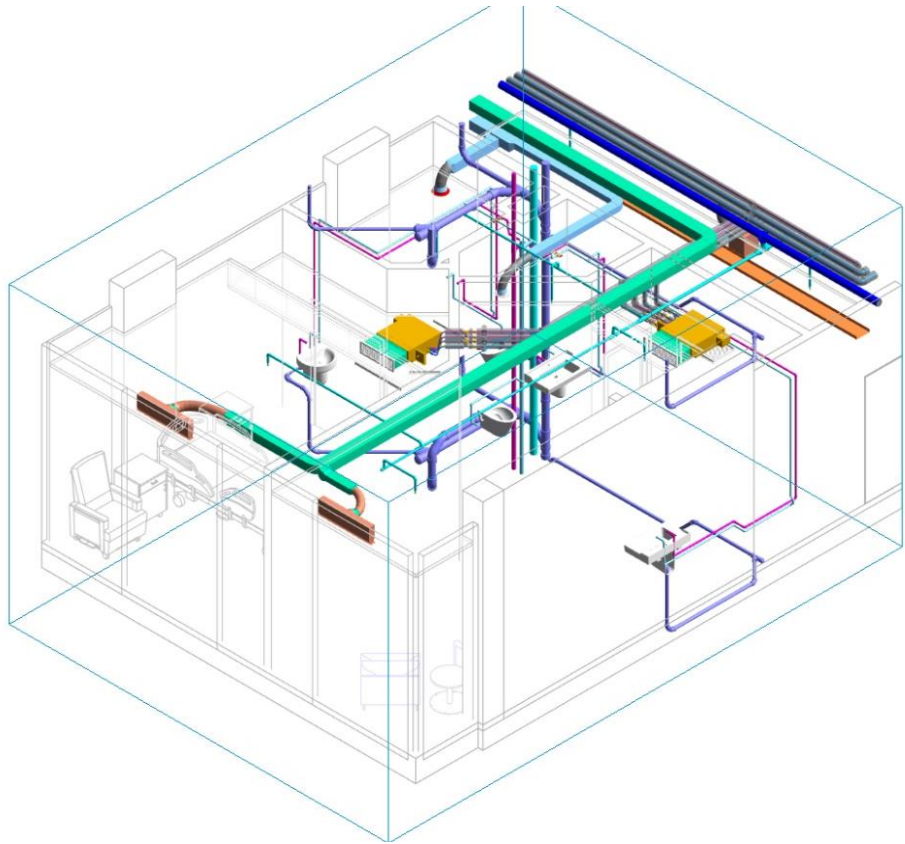

✓ Halk GYO Financial Center Office Project

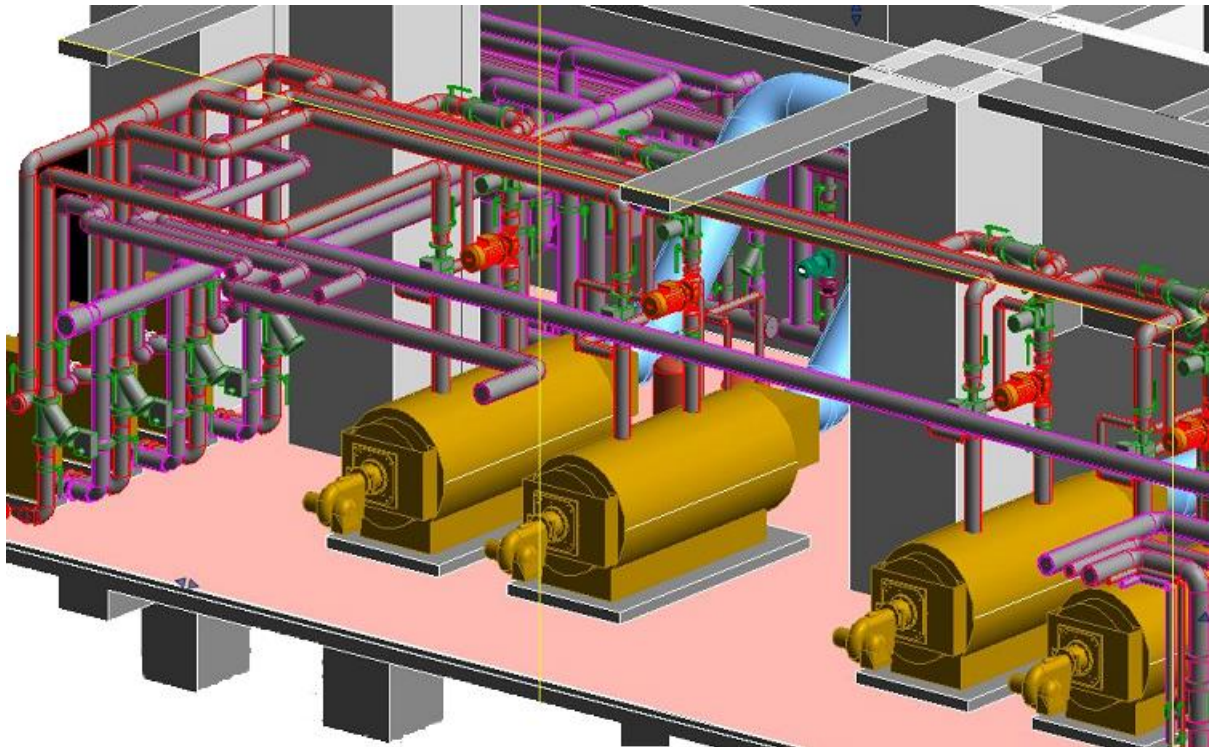
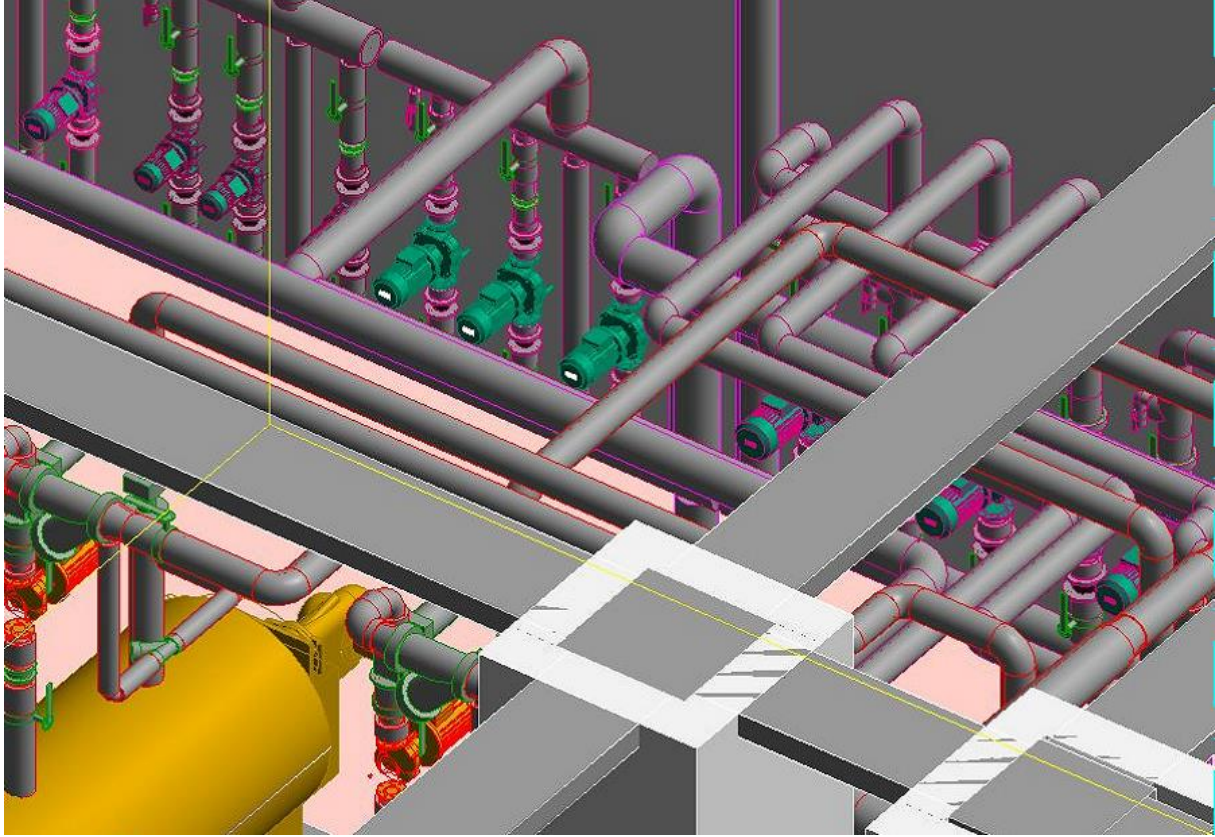





## DINAMIK PROJE SOME PROJECT REFERENCES

## Public Transportation Buildings, Airport Terminals and Train Stations

### Sabiha Gokcen International Airport Terminal Building

Location: **Istanbul / Turkey**  
Client: **Limak Construction Co. - GMR**  
Gross Area: **286.000 m<sup>2</sup>**  
Project Year: **2011**  
Scope: **Mechanical Engineering Services**



### Sabiha Gokcen International Airport Extension Project

Location: **Istanbul / Turkey**  
Client: **Tekeli Sisa**  
Gross Area: **25.000 m<sup>2</sup>**  
Project Year: **2018**  
Scope: **Mechanical Engineering Services**



## Istanbul New Airport THY International and Domestic Lounges

Location: **Istanbul / Turkey**  
Client: **MNG Targem**  
Gross Area: **20.000 m<sup>2</sup>**  
Project Year: **2016**  
Scope: **Mechanical Engineering Services**



## Antalya International Airport New Terminal Building

Location: **Antalya / Turkey**  
Client: **Celebi Inc.**  
Gross Area: **70.000 m<sup>2</sup>**  
Project Year: **2005**  
Scope: **Mechanical Engineering Services**





## Istanbul New Airport Car Park Project

Location: **Istanbul / Turkey**  
Client: **Hazan Architecture**  
Gross Area: **720.000 m<sup>2</sup>**  
Project Year: **2017**  
Scope: **Mechanical Engineering Services**



## Doha International Airport

Location: **Doha, Qatar**  
Client: **Ekin Co.**  
Gross Area: **110.000 m<sup>2</sup>**  
Project Year: **2009**  
Scope: **Partial Engineering Workings, Shop Drawings (15%)**



---

## Baku Airport Terminal Building District Heating and Cooling Center

Location: **Baku / Azerbaijan**  
Client: **MNG Group**  
Gross Area:  
Project Year: **2013**  
Scope: **Mechanical Engineering Services**



---

## Pristina Airport Terminal Building

Location: **Republic of Kosovo**  
Client: **Limak - GMR Unincorporated Company**  
Gross Area: **31.000 m<sup>2</sup>**  
Project Year: **2013**  
Scope: **Mechanical Engineering Services**





## Gence Airport International Terminal Building

Location: **Gence / Azerbaijan**  
Client: **EREN Construction Co.**  
Gross Area: **15.000 m<sup>2</sup>**  
Project Year: **2000**  
Scope: **Mechanical Engineering Services**



## Nakhichevan Airport

Location: **Nakhichevan / Azerbaijan**  
Client: **EREN Construction Co.**  
Gross Area: **20.000 m<sup>2</sup>**  
Project Year: **1999**  
Scope: **Mechanical Engineering Services**



---

## Vnukovo Airport New International Passengers Terminal

Location: **Moscow - Russia**  
Client: **SUMMA and GMW**  
Gross Area: **20.000 m<sup>2</sup>**  
Project Year: **2004**  
Scope: **Mechanical Engineering Services**



---

## Astana International Airport Terminal Building and Service Buildings

Location: **Astana / Kazakhstan**  
Client: **Alarko – Alsim**  
Gross Area: **40.000 m<sup>2</sup>**  
Project Year: **2005**  
Scope: **Mechanical Engineering Services**



## Erbil International Airport and VIP Building

Location: **Erbil / Iraq**  
Client: **Mak-Yol & Cengiz Co.**  
Gross Area: **75.000 m<sup>2</sup>**  
Project Year: **2009**  
Scope: **Mechanical Engineering Services**



## Heydar Aliyev International Airport

Location: **Baku / Azerbaijan**  
Client: **Enka Burc J.V. and Azal Co.**  
Gross Area: **60.000 m<sup>2</sup>**  
Project Year: **1998**  
Scope: **Mechanical Engineering Services**





---

## Bandaranaike International Airport

Location: **Sri Lanka**  
Client: **Scott Brownrigg**  
Gross Area: **200.000 m<sup>2</sup>**  
Project Year: **2020**  
Scope: **Mechanical Engineering Services**



---

## Istanbul New Airport MNG Service Building

Location: **Istanbul / Turkey**  
Client: **MNG Targem**  
Gross Area: **16.300 m<sup>2</sup>**  
Project Year: **2018**  
Scope: **Mechanical  
Engineering  
Services**

---

## Domodovo Airport New Terminal Building

Location: **Moscow / Russia**  
Client: **ANT Construction Co. - EA Arma Elektropanc Co**  
Gross Area: **230.000 m<sup>2</sup>**  
Project Year: **2016**  
Scope: **Mechanical Engineering Services (Preliminary Study)**

---

---

## Haramain High Speed Railway Madinah Station

Location: **Kingdom of Saudi Arabia**  
Client: **Yapi Merkezi Construction and Industry Co**  
Gross Area: **150.000 m<sup>2</sup>**  
Project Year: **2012**  
Scope: **Mechanical Engineering Services**



---

## Sar-AI Nariyah Workshop

Location: **Kingdom of Saudi Arabia**  
Client: **Yapi Merkezi Construction Industry Inc.**  
Gross Area: **95.000 m<sup>2</sup>**  
Project Year: **2012**  
Scope: **Mechanical Engineering Services**





## Kabatas Marti Transfer Hub Istanbul (Ferry, Boat and Metro Central Station)

Location: **Besiktas-Istanbul / Turkey**  
Client: **Hakan Kiran Architecture**  
Gross Area: **90.000 m<sup>2</sup>**  
Project Year: **2018**  
Scope: **Mechanical Engineering Services**



## Sogutlucemesme High Speed Train Station

Location: **Istanbul / Turkey**  
Client: **Tekeli Sisa**  
Gross Area: **70.000 m<sup>2</sup>**  
Project Year: **2018**  
Scope: **Tender Document Report**

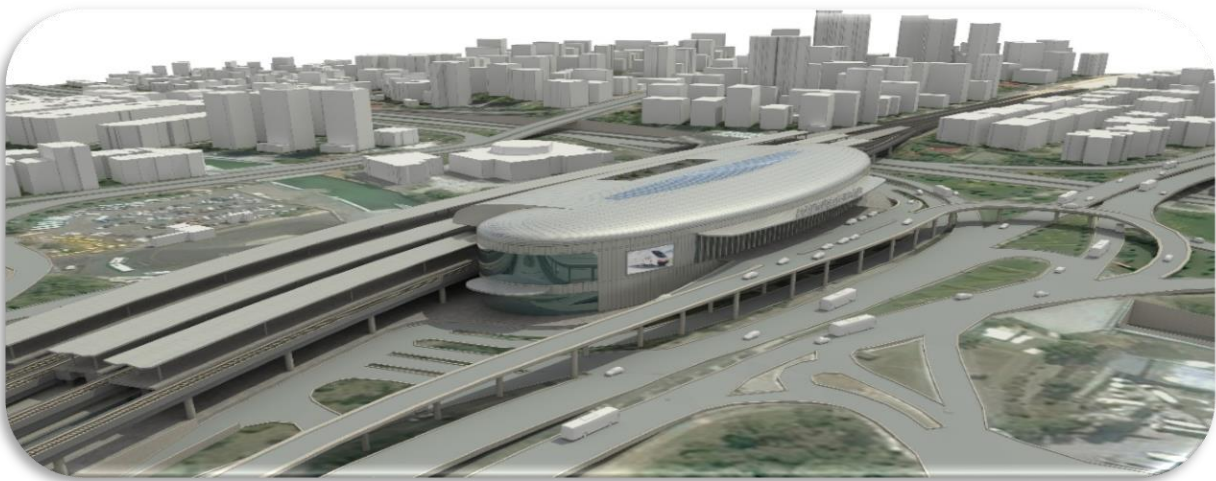

## Health Care Building Projects

### Italian Hospital (Branch of American Hospital)

Location: **Istanbul / Turkey**  
Client: **VKV**  
Gross Area: **10.000 m<sup>2</sup>**  
Project Year: **2002**  
Scope: **Mechanical Engineering Services**



### American Hospital Guzelbahce Clinic, Oncology Center, IVF and Emergency Services

Location: **Istanbul / Turkey**  
Client: **VKV**  
Gross Area: **20.000 m<sup>2</sup>**  
Project Year: **2006**  
Scope: **Mechanical Engineering Services**



### VKV Emergency Hospital

Location: **Haydarpaşa-Istanbul / Turkey**  
Client: **VKV**  
Gross Area: **10.000 m<sup>2</sup>**  
Project Year: **2001**  
Scope: **Mechanical Engineering Services**



### Palmed Group Hospital

Location: **Istanbul / Turkey**  
Client: **Pal Construction Co.**  
Gross Area: **20.000 m<sup>2</sup>**  
Project Year: **2011**  
Scope: **Mechanical Engineering Services**





---

## Muammer Agim Government Hospital

Location: **Bursa / Turkey**  
Client: **Sozuner Architecture**  
Gross Area: **8.000 m<sup>2</sup>**  
Project Year: **2003**  
Scope: **Mechanical Engineering Services**



---

## Suleyman Demirel University Hospital

Location: **Isparta / Turkey**  
Client: **Alarko - Alsim**  
Gross Area: **40.000 m<sup>2</sup>**  
Project Year: **2000**  
Scope: **Mechanical Engineering Services**



---

## Maternity Hospital

Location: **Moscow - Russia**  
Client: **Enka Inc.**  
Gross Area: **34.000 m<sup>2</sup>**  
Project Year: **2007**  
Scope: **Mechanical Engineering Services**



---

## Eye Hospital

Location: **Ashgabat - Turkmenistan**  
Client: **GAP Construction Sonmez Co.**  
Gross Area: **15.500 m<sup>2</sup>**  
Project Year: **2009**  
Scope: **Mechanical Engineering Services**





## Anadolu Health Center Bone Marrow Transplantation

Location: **Gebze / Turkey**  
Client: **Has Architectural Ltd.**  
Gross Area: **4.000 m<sup>2</sup>**  
Project Year: **2006**  
Scope: **Mechanical Engineering Services**



## Afiya Beauty Center

Location: **Florya-Istanbul / Turkey**  
Client: **Gulab Architecture**  
Gross Area: **2.215 m<sup>2</sup>**  
Project Year: **2017**  
Scope: **Mechanical Engineering Services**



## Life Med

Location: **Kadikoy-Istanbul / Turkey**  
Client: **Can Group**  
Gross Area: **1.500 m<sup>2</sup>**  
Project Year: **2004**  
Scope: **Mechanical Engineering Services**



## Hisar Intercontinental Hospital

Location: **Bagcilar-Istanbul / Turkey**  
Client: **Hisar Intercontinental  
Hospital Co. Inc.**  
Gross Area: **65.000 m<sup>2</sup>**  
Project Year:  
Scope: **Mechanical Engineering Services**



## Medipol Mega University Hospital

Location: **Bagcilar-Istanbul / Turkey**  
Client: **Medipol Hospital**  
Gross Area: **50.000 m<sup>2</sup>**  
Project Year: **2018**  
Scope: **Mechanical Engineering Services**



## Rückkühlwerke Hospital Project

Location: **Germany**  
Client: **German Design Group**  
Gross Area: **7.000 m<sup>2</sup>**  
Project Year: **2019**  
Scope: **Partial detailed design services to German design group**

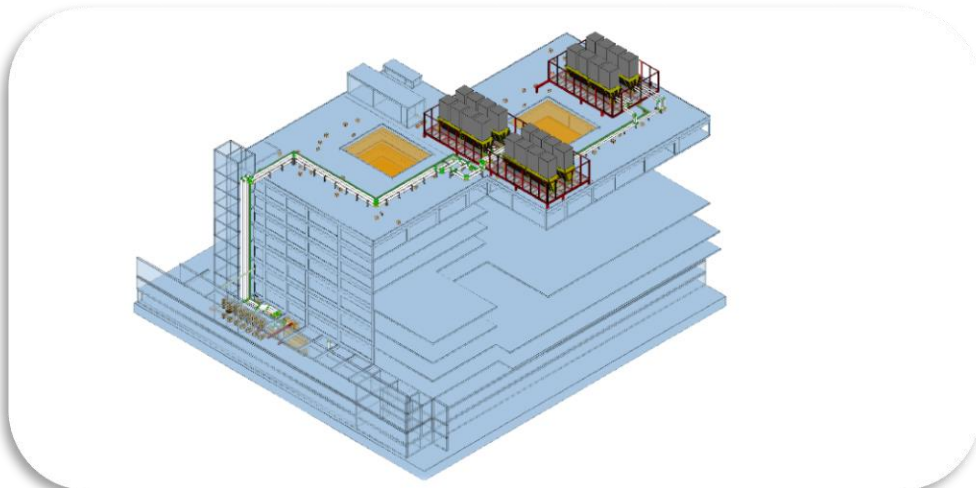



---

## High Technological Multifunctional Medical Complex (Multidisciplinary Medical Center-Oncology Center)

Location: **St. Petersburg - Russia**  
Client: **Enka**  
Gross Area: **110.000 m<sup>2</sup>**  
Project Year: **2021**  
Scope: **Mechanical Engineering Services**



---

## Handicap Children Stomatology Hospital Center

Location: **Moscow - Russia**  
Client: **URBAN Co.**  
Gross Area: **12.000 m<sup>2</sup>**  
Project Year: **2006**  
Scope: **Mechanical Engineering Services**

---

## Konya Pulmonary Diseases Hospital

Location: **Konya / Turkey**  
Client: **Ministry of Public Work**  
Gross Area: **25.000 m<sup>2</sup>**  
Project Year: **1999**  
Scope: **Mechanical Engineering Services**

---

## Shopping Malls and Retail Building Projects

### Buyaka Residence, Office Shopping Mall Project

Location: **Istanbul / Turkey**  
Client: **Artel Building Construction Co.**  
Gross Area: **200.000 m<sup>2</sup>**  
Project Year: **2004**  
Scope: **Mechanical Engineering Services**



### Kuntsevo Multifunctional Shopping Center

Location: **Moscow / Russia**  
Client: **Enka Construction**  
Gross Area: **240.000 m<sup>2</sup>**  
Project Year: **2015**  
Scope: **Mechanical Engineering Services**





## Kashirskaya Multifunctional Shopping Center

Location: **Moscow / Russia**  
Client: **Enka Co.**  
Gross Area: **190.000 m<sup>2</sup>**  
Project Year: **2017**  
Scope: **Mechanical Engineering Services**



## Sultanbeyli Office and Shopping Mall Project

Location: **Istanbul / Turkey**  
Client: **Mesturkuaz Joint Venture**  
Gross Area: **118.000 m<sup>2</sup>**  
Project Year: **2012**  
Scope: **Mechanical Engineering Services**





## Palladium Shopping Center and Residence (30 Floors)

Location: **Istanbul / Turkey**  
Client: **Tahincioglu Holding**  
Gross Area: **200.000 m<sup>2</sup>**  
Project Year: **2004**  
Scope: **Mechanical  
Engineering  
Services**



## Antakya Palladium Shopping Mall

Location: **Antakya / Turkey**  
Client: **Tahincioglu Holding**  
Gross Area: **104.000 m<sup>2</sup>**  
Project Year: **2009**  
Scope: **Mechanical  
Engineering  
Services**



## Sancaktepe Rings Istanbul

Location: **Istanbul / Turkey**  
Client: **Hakan Kiran Architectural**  
Gross Area: **369.000 m<sup>2</sup>**  
Project Year: **2012**  
Scope: **Mechanical  
Engineering  
Services**



## Kabul Markaz Mixed Use Project

Location: **Afghanistan**  
Client: **Mohib Holding**  
Gross Area: **50.000 m<sup>2</sup>**  
Project Year: **2018**  
Scope: **Mechanical  
Engineering  
Services**



### 14 Burda Shopping Mall Project

Location: **Bolu / Turkey**  
Client: **Esasburda Construction Inc.**  
Gross Area: **28.000 m<sup>2</sup>**  
Project Year: **2015**  
Scope: **Mechanical  
Engineering  
Services**



### 01 Burda Shopping Mall Project

Location: **Adana / Turkey**  
Client: **Esasburda Construction Inc.**  
Gross Area: **170.000 m<sup>2</sup>**  
Project Year: **2016**  
Scope: **Mechanical  
Engineering  
Services**



### 10 Burda Shopping Mall Project

Location: **Balikesir / Turkey**  
Client: **Esasburda Construction Inc.**  
Gross Area: **120.000 m<sup>2</sup>**  
Project Year: **2017**  
Scope: **Mechanical  
Engineering  
Services**



### 39 Burda Shopping Mall Project

Location: **Luleburgaz / Turkey**  
Client: **Esasburda Construction Inc.**  
Gross Area: **40.000 m<sup>2</sup>**  
Project Year: **2017**  
Scope: **Mechanical  
Engineering  
Services**





## Agora Shopping Mall Project

Location: **Izmir / Turkey**  
Client: **Odak Group  
Construction Inc.**  
Gross Area: **140.000 m<sup>2</sup>**  
Project Year: **2017**  
Scope: **Mechanical  
Engineering  
Services**



## Istanbul International Financial Center Agaoglu Office – Residence Shopping Mall Project

Location: **Atasehir-Istanbul / Turkey**  
Client: **Camoglu Architecture**  
Gross Area: **810.000 m<sup>2</sup>**  
Project Year: **2017**  
Scope: **Mechanical  
Engineering  
Services (50%)**



## Emaar Square

Location: **Istanbul / Turkey**  
Client:  
Gross Area: **275.000 m<sup>2</sup>**  
Project Year: **2015**  
Scope: **3D Revit BIM Modelling,  
Coordination,  
Shop Drawing**



## Ramstore Vernatskovo

Location: **Moscow / Russia**  
Client: **RAM ENKA Inc.  
(Loft and Erözü Architectural)**  
Gross Area: **132.000 m<sup>2</sup>**  
Project Year: **2006**  
Scope: **Mechanical  
Engineering  
Services**





---

## Kemerovo Shopping Center

Location: **Kemerovo / Russia**  
Client: **Loft Architectural  
Erozu Architectural**  
Gross Area: **30.000 m<sup>2</sup>**  
Project Year: **2010**  
Scope: **Mechanical  
Engineering  
Services**



---

## Novosibirsk Shopping Center

Location: **Novosibirsk / Russia**  
Client: **Loft Architectural  
Erözü Architectural**  
Gross Area: **53.000 m<sup>2</sup>**  
Project Year: **2008**  
Scope: **Mechanical  
Engineering  
Services**



---

## Castorama Shopping Center

Location: **Rostov / Russia**  
Client: **Beta Construction Co.**  
Gross Area: **13.000 m<sup>2</sup>**  
Project Year: **2010**  
Scope: **Mechanical  
Engineering  
Services**



---

## Real Commercial Center

Location: **Brateevo - Moscow / Russia**  
Client: **RAM Enka Inc.**  
Gross Area: **60.000 m<sup>2</sup>**  
Project Year: **2008**  
Scope: **Mechanical  
Engineering  
Services**



---

### Ikea - Obi Shopping Center Kommunarka

Location: **Moscow / Russia**  
Client: **Enka Inc.**  
Gross Area: **16.500 m<sup>2</sup>**  
Project Year: **2009**  
Scope: **Mechanical  
Engineering  
Services**



---

### Ikea - Obi Shopping Center Khimki

Location: **Moscow / Russia**  
Client: **Enka Inc.**  
Gross Area: **16.500 m<sup>2</sup>**  
Project Year: **2009**  
Scope: **Mechanical  
Engineering  
Services**



---

### Ikea - Obi Shopping Center St Petersburg

Location: **St. Petersburg / Russia**  
Client: **Enka Inc.**  
Gross Area: **32.000 m<sup>2</sup>**  
Project Year: **2008**  
Scope: **Mechanical  
Engineering  
Services**



---

### Ikea Mega Ufa Shopping Center

Location: **Ufa / Russia**  
Client: **Kayi - Desat Groups**  
Gross Area: **240.000 m<sup>2</sup>**  
Project Year: **2008**  
Scope: **Mechanical  
Engineering  
Services**



---

### Hotel and Shopping Center

Location: **Taganrog / Russia**  
Client: **Loft Architectural  
Erozu Architectural**  
Gross Area: **55.000 m<sup>2</sup>**  
Project Year: **2009**  
Scope: **Mechanical  
Engineering  
Services**

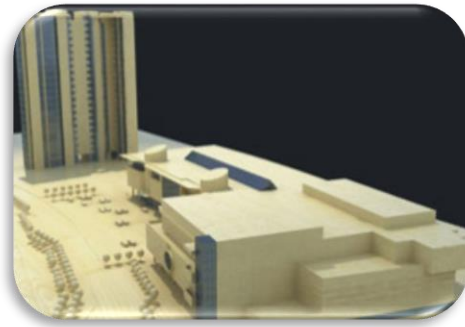

---

### Ramstore Sevastopolsky

Location: **Moscow / Russia**  
Client: **RAM ENKA Inc.**  
Gross Area: **65.000 m<sup>2</sup>**  
Project Year: **2004**  
Scope: **Mechanical Engineering Services**



---

### Mega Shopping Center

Location: **St Petersburg / Russia**  
Client: **Energostory**  
Gross Area: **244.265 m<sup>2</sup>**  
Project Year: **2006**  
Scope: **Mechanical Engineering Services**



---

### Galeria Shopping Mall

Location: **Kostence / Romania**  
Client:  
Gross Area: **22.000 m<sup>2</sup>**  
Project Year: **2002**  
Scope: **Mechanical Engineering Services**





---

### Diler Holding Shopping Center

Location: **Bostanci-Istanbul / Turkey**  
Client: **Tago Architectural**  
Gross Area: **44.000 m<sup>2</sup>**  
Project Year: **2009**  
Scope: **Mechanical  
Engineering  
Service**



---

### Galatasaray TT Arena GS Store Building

Location: **Seyrantepe-Istanbul / Turkey**  
Client: **Galatasaray SK Marketing Co**  
Gross Area: **1.500 m<sup>2</sup>**  
Project Year: **2010**  
Scope: **Mechanical  
Engineering  
Services**



---

### Murmansk Shopping Center

Location: **Moscow / Russia**  
Client: **Sinerji Co  
Erozu Architectural**  
Gross Area: **20.000 m<sup>2</sup>**  
Project Year: **2008**  
Scope: **Mechanical Engineering Services**

---

### Ramstore Leningradsky

Location: **Moscow / Russia**  
Client: **Enka Construction Co. Inc.**  
Gross Area: **70.000 m<sup>2</sup>**  
Project Year: **2005**  
Scope: **Mechanical Engineering Services**

---

---

## **Karamancilar Office Building and Shopping Center**

Location: **Istanbul / Turkey**  
Client: **Karamanci Holding**  
Gross Area: **50.000 m<sup>2</sup>**  
Project Year: **2009**  
Scope: **Mechanical Engineering Services**

---

---

## **Med - Marin Shopping Center**

Location: **Istanbul / Turkey**  
Client:  
Gross Area: **20.000 m<sup>2</sup>**  
Project Year: **2007**  
Scope: **Mechanical Engineering Services**

---

---

## **Ramstore Podolsk**

Location: **Moscow / Russia**  
Client: **RAM ENKA Inc.**  
Gross Area: **18.000 m<sup>2</sup>**  
Project Year: **2007**  
Scope: **Mechanical Engineering Services**

---

---

## **Continent Commercial Center**

Location: **Istanbul / Turkey**  
Client: **Baytur Co.**  
Gross Area: **80.000 m<sup>2</sup>**  
Project Year: **2002**  
Scope: **Mechanical Engineering Services**

---

---

## Yeni Hasdayi Shopping Center and Saraybahce Municipality Marriage Office

Location: **Kocaeli / Turkey**  
Client: **Izmit Municipality**  
Gross Area: **33.000 m<sup>2</sup>**  
Project Year: **2004**  
Scope: **Mechanical Engineering Services**

---

---

## Shopping Center

Location: **Bucharest / Romania**  
Client: **Bayraktar Holding**  
Gross Area: **70.000 m<sup>2</sup>**  
Project Year: **2001**  
Scope: **Mechanical Engineering Services**

---

---

## Samara Trade Center

Location: **Samara / Russia**  
Client: **Monotek Co**  
Gross Area: **35.000 m<sup>2</sup>**  
Project Year: **2008**  
Scope: **Mechanical Engineering Services**

---

---

## Real Commercial Centre

Location: **Signalny - Moscow / Russia**  
Client: **RAM ENKA Inc.**  
Gross Area: **32.000 m<sup>2</sup>**  
Project Year: **2006**  
Scope: **Mechanical Engineering Services**

---



---

## Kalinka Malinka Shopping Center

Location: **Rostov / Russia**  
Client: **Sinerji Co**  
Gross Area: **72.000 m<sup>2</sup>**  
Project Year: **2009**  
Scope: **Mechanical Engineering Services**

---

---

## Eskisehir Shopping Mall

Location: **Eskisehir / Turkey**  
Client:  
Gross Area: **70.000 m<sup>2</sup>**  
Project Year: **2017**  
Scope: **Mechanical Engineering Services**

---

---

## Cavusdere Mixed Used Project

Location: **Uskudar-Istanbul / Turkey**  
Client: **Kalyon Insaat**  
Gross Area: **123.000 m<sup>2</sup>**  
Project Year: **2017**  
Scope: **Mechanical Engineering Services**

---

---

## Selway Outlet

Location: **Istanbul / Turkey**  
Client:  
Gross Area: **100.000 m<sup>2</sup>**  
Project Year: **2018**  
Scope: **Mechanical Engineering Services**

---

## Office Building Projects

---

### **Soyak Tower (QNB Finansbank)**

Location: **Sisli-Istanbul / Turkey**  
Client: **Soyak Construction**  
Gross Area: **85.000 m<sup>2</sup>**  
Project Year: **2011**  
Scope: **Mechanical  
Engineering  
Services**



### **Palladium Office Tower**

Location: **Atasehir-Istanbul / Turkey**  
Client: **Tahincioglu Holding**  
Gross Area: **75.000 m<sup>2</sup>**  
Project Year: **2011**  
Scope: **Mechanical  
Engineering  
Services**



### **The Olive Grove Tower (Garanti Bankasi)**

Location: **Levent-Istanbul / Turkey**  
Client: **Dogus Invest Co**  
Gross Area: **65.000 m<sup>2</sup>**  
Project Year: **2004**  
Scope: **Mechanical  
Engineering  
Services**



---

### Is GYO Financial Center Office Project

Location: **Istanbul / Turkey**  
Client: **HOK - Dome Natural Spaces Architecture**  
Gross Area: **70.000 m<sup>2</sup>**  
Project Year: **2016**  
Scope: **Mechanical Engineering Service**



---

### TCMB Headquarter Building Financial Center Office Project Building

Location: **Istanbul / Turkey**  
Client: **HPP International**  
Gross Area: **250.000 m<sup>2</sup>**  
Project Year: **2016**  
Scope: **Tender Document**



---

### Halk GYO Financial Center Office Project

Location: **Istanbul / Turkey**  
Client: **AECOM - Seyas Co. Inc.**  
Gross Area: **440.000 m<sup>2</sup>**  
Project Year: **2016**  
Scope: **Mechanical Engineering Service**





---

**Istanbul International  
Financial Center  
Agaoglu Office - Residence  
Shopping Mall Project**

Location: **Atasehir-Istanbul / Turkey**  
Client: **Camoglu Architecture**  
Gross Area: **810.000 m<sup>2</sup>**  
Project Year: **2017**  
Scope: **Mechanical Engineering Services**



---

**Nidakule Atasehir Office West Project**

Location: **Istanbul / Turkey**  
Client: **Tahincioglu Holding**  
Gross Area: **46.200 m<sup>2</sup>**  
Project Year: **2015**  
Scope: **Mechanical  
Engineering  
Service**



---

**Nidakule Atasehir Office North Project**

Location: **Atasehir-Istanbul / Turkey**  
Client: **Tahincioglu Holding**  
Gross Area: **121.000 m<sup>2</sup>**  
Project Year: **2014**  
Scope: **Mechanical  
Engineering  
Services**



---

## Nidakule Atasehir Office South Project

Location: **Atasehir-Istanbul / Turkey**  
Client: **Tahincioglu Holding**  
Gross Area: **54.000 m<sup>2</sup>**  
Project Year: **2014**  
Scope: **Mechanical  
Engineering  
Services**



---

## Flame Towers – Office Building

Location: **Baku / Azerbaijan**  
Client: **DIA Holding**  
Gross Area: **230.000 m<sup>2</sup>**  
Project Year: **2012**  
Scope: **Mechanical  
Engineering  
Services**



---

## Nidapark Kucukyali Office Buildings

Location: **Maltepe-Istanbul / Turkey**  
Client: **Tahincioglu Holding**  
Gross Area: **360.000 m<sup>2</sup>**  
Project Year: **2017**  
Scope: **Mechanical  
Engineering  
Services**



---

### **Kartal Manzara Adalar Residence and Office Project**

Location: **Kartal-Istanbul / Turkey**  
Client: **IS Real Estate Investment Trust**  
Gross Area: **315.000 m<sup>2</sup>**  
Project Year: **2016**  
Scope: **Mechanical  
Engineering  
Services**



---

### **Donstroy - 2 Multi Store Buildings Project (40 Floors)**

Location: **Moscow / Russia**  
Client: **Enka Construction Co. Inc.**  
Gross Area: **200.000 m<sup>2</sup>**  
Project Year: **2010**  
Scope: **Mechanical  
Engineering  
Services**



---

### **Residence - Office Tsvetnoy Avenue Project**

Location: **Moscow / Russia**  
Client: **Enka Construction Co. Inc.**  
Gross Area: **120.296 m<sup>2</sup>**  
Project Year: **2010**  
Scope: **Mechanical  
Engineering  
Services**





### Max and Moritz

Location: **Berlin / Germany**  
Client: **Mikare**  
Gross Area: **60.000 m<sup>2</sup>**  
Project Year: **2018**  
Scope: **Detailed design services to German design group**



### Bomonti Tower Office Building

Location: **Sisli-Istanbul / Turkey**  
Client: **Fer Yapi Real Estate Development And Construction**  
Gross Area: **41.500 m<sup>2</sup>**  
Project Year: **2011**  
Scope: **Mechanical Engineering Services**



### Istanbulloom Tower Zincirlikuyu Office Project

Location: **Zincirlikuyu-Istanbul / Turkey**  
Client: **Esin Yapi**  
Gross Area: **62.140 m<sup>2</sup>**  
Project Year: **2011**  
Scope: **Mechanical Engineering Service**



### Ferko Signature Office Project

Location: **Levent-Istanbul / Turkey**  
Client: **Eria Co.**  
Gross Area: **140.000 m<sup>2</sup>**  
Project Year: **2015**  
Scope: **Mechanical  
Engineering  
Service**



### Kartal Kuris Plaza Office Building

Location: **Kartal-Istanbul / Turkey**  
Client: **Kilicoglu Delta Ltd. Co**  
Gross Area: **53.722 m<sup>2</sup>**  
Project Year: **2014**  
Scope: **Mechanical  
Engineering  
Services**



### Nidakule Goztepe Office Tower

Location: **Goztepe-Istanbul / Turkey**  
Client: **Tahincioglu Holding**  
Gross Area: **46.000 m<sup>2</sup>**  
Project Year: **2009**  
Scope: **Mechanical  
Engineering  
Services**



---

## Ministry of Health Building

Location: **Ashgabat / Turkmenistan**  
Client: **GAP Construction Co**  
Gross Area: **12.000 m<sup>2</sup>**  
Project Year: **2009**  
Scope: **Mechanical  
Engineering  
Services**



---

## Kilicoglu Mermerler Plaza Office Project

Location: **Kozyatagi-Istanbul / Turkey**  
Client: **Kilicoglu Construction**  
Gross Area: **25.500 m<sup>2</sup>**  
Project Year: **2014**  
Scope: **Mechanical  
Engineering  
Service**



---

## Maslak Link Office Building Project

Location: **Maslak-Istanbul / Turkey**  
Client: **Kapital Real Estate Investment  
Development Co. Inc.**  
Gross Area: **30.000 m<sup>2</sup>**  
Project Year: **2015**  
Scope: **Mechanical  
Engineering  
Service**





---

### Maslak Square Office Building Project

Location: **Maslak-Istanbul / Turkey**  
Client: **Kapital Real Estate Investment Development Co. Inc.**  
Gross Area: **90.000 m<sup>2</sup>**  
Project Year: **2017**  
Scope: **Mechanical Engineering Service**



---

### Bikur Plaza Office Building

Location: **Kagithane-Istanbul / Turkey**  
Client: **Bikur Construction**  
Gross Area: **10.500 m<sup>2</sup>**  
Project Year: **2013**  
Scope: **Mechanical Engineering Service**



---

### Galatasaray TT Arena Office Building

Location: **Seyrantepe-Istanbul / Turkey**  
Client: **Galatasaray SK Marketing Co**  
Gross Area: **3.000 m<sup>2</sup>**  
Project Year: **2010**  
Scope: **Mechanical Engineering Service**



---

### Maya Anatolium Kartal Mix Use Project

Location: **Kartal-Istanbul / Turkey**  
Client: **Maya & Yilsan Partnership**  
Gross Area: **200.000 m<sup>2</sup>**  
Project Year: **2016**  
Scope: **Mechanical Engineering Service**



---

### Kayi Group Head Office Building

Location: **Antalya / Turkey**  
Client: **Kayi Group**  
Gross Area: **25.000 m<sup>2</sup>**  
Project Year: **2011**  
Scope: **Mechanical Engineering Service**



---

### Ncade Ottoman Office Project

Location: **Istanbul / Turkey**  
Client: **Ozyurtlar Construction Inc.**  
Gross Area: **68.900 m<sup>2</sup>**  
Project Year: **2016**  
Scope: **Mechanical Engineering Service**



---

### Oryapark Umraniye Istanbul

Location: **Umraniye-Istanbul / Turkey**  
Client: **Oryatas Construction Inc.**  
Gross Area: **50.000 m<sup>2</sup>**  
Project Year: **2017**  
Scope: **Mechanical Engineering Service (30 %)**



---

### Esas Business Park Project

Location: **Kurtkoy-Istanbul / Turkey**  
Client: **Esas Holding**  
Gross Area: **47.500 m<sup>2</sup>**  
Project Year: **2010**  
Scope: **Mechanical  
Engineering  
Service**



---

### Musiad HQ Office Project

Location: **Istanbul / Turkey**  
Client: **Scala Architecture**  
Gross Area: **10.000 m<sup>2</sup>**  
Project Year: **2017**  
Scope: **Mechanical  
Engineering  
Service**



---

### Kuyas & Bias GYO Office Project

Location: **Istanbul / Turkey**  
Client: **Kuyas GYO Co.**  
Gross Area: **33.742 m<sup>2</sup>**  
Project Year: **2014**  
Scope: **Mechanical  
Engineering  
Service**



---

### Oyak Renault Management Building

Location: **Bursa / Turkey**  
Client: **OYAK**  
Gross Area: **15.000 m<sup>2</sup>**  
Project Year: **2006**  
Scope: **Mechanical  
Engineering  
Service**





---

### Embassy Building of Turkish Republic

Location: **Dushanbe / Tajikistan**  
Client: **TUPRAS New group of workshops**  
Gross Area:  
Project Year: **2003**  
Scope: **Mechanical Engineering Services**



---

### Bilim Pharmaceuticals Office Building

Location: **Maslak-Istanbul / Turkey**  
Client: **Kar Gayrimenkul**  
Gross Area: **48.250 m<sup>2</sup>**  
Project Year: **2013**  
Scope: **Mechanical Engineering Services**



---

### Mercedes Office Building

Location: **Istanbul / Turkey**  
Client: **Turgut Alton Architectural Co. Ltd**  
Gross Area: **12.500 m<sup>2</sup>**  
Project Year:  
Scope: **Mechanical Engineering Services**



---

## Maltepe Municipality Building

Location: **Maltepe-Istanbul / Turkey**  
Client: **Tahincioglu Holding**  
Gross Area: **30.000 m<sup>2</sup>**  
Project Year: **2017**  
Scope: **Mechanical  
Engineering  
Services**



---

## Fer Yapi Office Project

Location: **Kagithane-Istanbul / Turkey**  
Client: **Fer Yapi Real Estate Development  
And Construction**  
Gross Area: **95.000 m<sup>2</sup>**  
Project Year: **2014**  
Scope: **Mechanical  
Engineering  
Services**



---

## Astyx - 1 Office Projects

Location: **Stuttgart / Germany**  
Client: **German Design Group**  
Gross Area: **7.000 m<sup>2</sup>**  
Project Year: **2019**  
Scope: **Detailed design services to  
German design group**



---

## Astyx - 2 Office Projects

Location: **Stuttgart / Germany**  
Client: **German Design Group**  
Gross Area: **9.000 m<sup>2</sup>**  
Project Year: **2019**  
Scope: **Detailed design services to  
German design group**



---

### Stihl Office Project

Location: **Germany**  
Client: **German Design Group**  
Gross Area: **17.000 m<sup>2</sup>**  
Project Year: **2019**  
Scope: **Detailed design services to German design group**



---

### Infineon Office Project

Location: **Germany**  
Client: **German Design Group**  
Gross Area: **20.000 m<sup>2</sup>**  
Project Year: **2019**  
Scope: **Partial detailed design services to German design group**

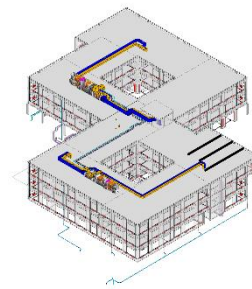

---

### Traenke Office Project

Location: **Germany**  
Client: **German Design Group**  
Gross Area: **7.000 m<sup>2</sup>**  
Project Year: **2019**  
Scope: **Partial detailed design services to German design group**

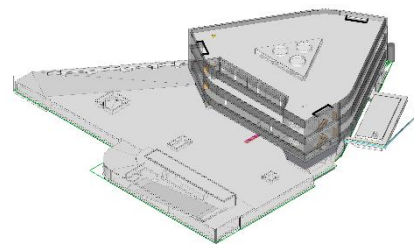

---

### Trumpf Office Project

Location: **Germany**  
Client: **German Design Group**  
Gross Area: **8.000 m<sup>2</sup>**  
Project Year: **2019**  
Scope: **Detailed design services to German design group**

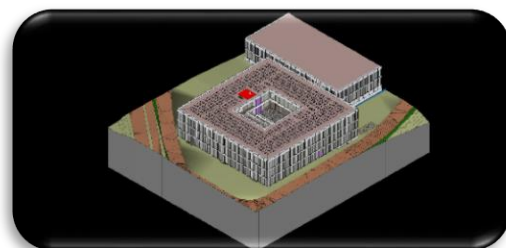



---

### Kale Ayazaga Office

Location: **Ayazaga - Istanbul / Turkey**  
Client: **Kale Kilit**  
Project Year: **2019**  
Gross Area: **10.000 m<sup>2</sup>**  
Scope: **Mechanical Engineering Services**



---

### Ncadde Agora Office Project

Location: **Istanbul / Turkey**  
Client: **Ozyurtlar Construction Inc.**  
Gross Area: **25.000 m<sup>2</sup>**  
Project Year: **2016**  
Scope: **Mechanical Engineering Services**



---

### Moscow City Transport Terminal Building Project

Location: **Moscow / Russia**  
Client: **Arcad Architectural Co., Ltd.**  
Gross Area: **240.000 m<sup>2</sup>**  
Project Year: **2009**  
Scope: **Mechanical Engineering Service (60%)**

---

### VIP Building

Location: **Ashgabat - Turkmenistan**  
Client: **GAP Construction Co.**  
Gross Area: **10.000 m<sup>2</sup>**  
Project Year: **2007**  
Scope: **Mechanical Engineering Services**

---

---

### Nidapark Cengelkoy

Location: **Cengelkoy-Istanbul / Turkey**  
Client: **Tahincioglu Holding**  
Gross Area: **70.000 m<sup>2</sup>**  
Project Year: **2017**  
Scope: **Mechanical Engineering Services (50%)**

---

---

### Kale Group Office Project

Location: **Istanbul / Turkey**  
Client: **Kale Topkapi Isletme ve Gayrimenkul Gelistirme Inc.**  
Gross Area: **11.250 m<sup>2</sup>**  
Project Year: **2006**  
Scope: **Mechanical Engineering Services**

---

---

### Mersin Ford Office Building

Location: **Mersin / Turkey**  
Client: **Ergin Motorlu Araclar Ticaret A.Ş.**  
Gross Area: **40.000 m<sup>2</sup>**  
Project Year: **2017**  
Scope: **Mechanical Engineering Service**

---

---

### PAK Maslak Office Building

Location: **Istanbul / Turkey**  
Client:  
Gross Area: **20.000 m<sup>2</sup>**  
Project Year: **2009**  
Scope: **Mechanical Engineering Service**

---

---

### Merdivenkoy Office Building

Location: **Istanbul / Turkey**  
Client:  
Gross Area: **20.000 m<sup>2</sup>**  
Project Year: **2008**  
Scope: **Mechanical Engineering Service**

---

---

## Capital Partners Projects

Location: **Almaty / Kazakhstan**  
Client: **GH Co**

**1-Turan Site-----165.000 m<sup>2</sup>**  
**2-Alliance Site-----120.000 m<sup>2</sup>**  
**3-Markova Site-----158.000 m<sup>2</sup>**

Scope: **Mechanical Engineering Services**

---

---

## Mercedes Office Building

Location: **Moscow / Russia**  
Client: **Sinerji Co., Ltd**  
Gross Area: **37.500 m<sup>2</sup>**  
Project Year: **2008**  
Scope: **Mechanical Engineering Service**

---



## Industrial Facilities Projects

---

### **Bosch Bursa Old Factory Facilities**

Location: **Bursa / Turkey**  
Client: **Bosch**  
Gross Area: **100.000 m<sup>2</sup>**  
Project Year: **2009**  
Scope: **Mechanical Engineering Services**

---



### **Bosch and Rexroth Factory Production Buildings**

Location: **Bursa / Turkey**  
Client: **Bosch**  
Gross Area: **30.000 m<sup>2</sup>**  
Project Year: **2009**  
Scope: **Mechanical Engineering Services**

---



### **Bosch Rexroth Factory Facility Buildings**

Location: **Bursa / Turkey**  
Client: **Bosch Rexroth**  
Gross Area: **53.000 m<sup>2</sup>**  
Project Year: **2008**  
Scope: **Mechanical Engineering Services**

---



### **Bosch Rexroth Factory Phase -2 Project**

Location: **Bursa / Turkey**  
Client: **Bosch Rexroth**  
Gross Area: **- m<sup>2</sup>**  
Project Year: **2009**  
Scope: **Mechanical Engineering Services**

---



---

## Amasya Meat Production Plant (Burger King Group)

Location: **Amasya / Turkey**  
Client: **Ekur Et Entegre Industry and Trade Inc.**  
Gross Area: **38.000 m<sup>2</sup>**  
Project Year: **2015**  
Scope: **Mechanical Engineering Services**



---

## Unilever Vector Factory Facility

Location: **Konya / Turkey**  
Client: **Jacobs Engineering and Tekeli-Sisa Architectural Group**  
Gross Area: **82.500 m<sup>2</sup>**  
Project Year: **2016**  
Scope: **Mechanical Engineering Services**

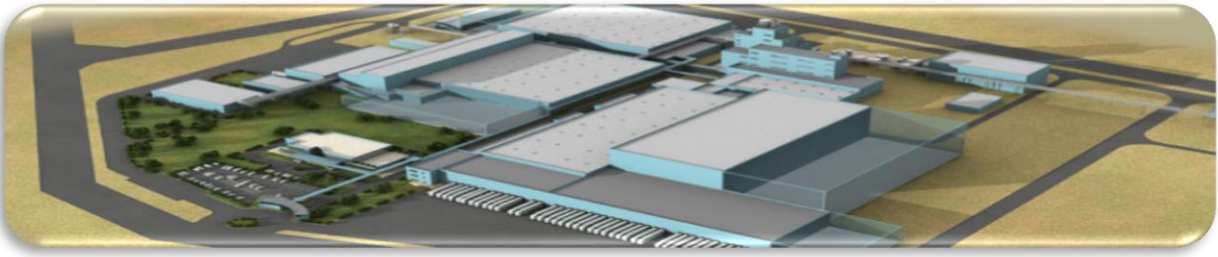

---

## Unilever Bosphorus Factory Facility

Location: **Konya / Turkey**  
Client: **Jacobs Engineering and Tekeli-Sisa Architectural Group**  
Gross Area: **56.000 m<sup>2</sup>**  
Project Year: **2014**  
Scope: **Mechanical Engineering Services**



---

### Altınmarka Veliefendi Cocoa Factory & Kahve Dünyası

Location: **Zeytinburnu-Istanbul / Turkey**  
Client: **Detay Gıda San. ve Tic. Inc.**  
Gross Area: **18.000 m<sup>2</sup>**  
Project Year: **2015**  
Scope: **Mechanical Engineering Services**



---

### Altınmarka Cacao and Chocolate Factories

Location: **Hadimkoy-Istanbul / Turkey**  
Client: **Detay Gıda San. ve Tic. Inc.**  
Gross Area: **60.000 m<sup>2</sup>**  
Project Year: **2000**  
Scope: **Mechanical Engineering Services**



---

### Altınmarka - Coffee Factory

Location: **Hadimkoy-Istanbul / Turkey**  
Client: **Detay Gıda San. ve Tic. Inc.**  
Gross Area: **15.000 m<sup>2</sup>**  
Project Year: **2002**  
Scope: **Mechanical Engineering Services**



---

### Altınmarka - Branch Factory

Location: **Kemberburgaz-Istanbul / Turkey**  
Client: **Detay Gıda San. ve Tic. Inc.**  
Gross Area: **5.000 m<sup>2</sup>**  
Project Year: **2012**  
Scope: **Mechanical Engineering Services**





---

### Altınmarka - Chocolate Factory

Location: **Catalca-Istanbul / Turkey**  
Client: **Detay Gıda San. ve Tic. Inc.**  
Gross Area: **16.000 m<sup>2</sup>**  
Project Year: **2013**  
Scope: **Mechanical Engineering Services**



---

### Philip Morris Tobacco Factory

Location: **Almaty / Kazakhstan**  
Client: **Alarko Alsim**  
Gross Area: **40.000 m<sup>2</sup>**  
Project Year: **2000**  
Scope: **Mechanical Engineering Services**



---

### Philip Morris Tobacco Factory

Location: **St. Petersburg / Russia**  
Client: **Enka Construction Co. Inc.**  
Gross Area: **60.000 m<sup>2</sup>**  
Project Year: **2005**  
Scope: **Mechanical Engineering Services**



---

### Unilever Scoop Laboratory

Location: **Sarıgazi-Istanbul / Turkey**  
Client: **Unilever Engineering Group**  
Gross Area: **3.000 m<sup>2</sup>**  
Project Year: **2014**  
Scope: **Mechanical Engineering Services**



---

## Pasabahce Factory Facility Renovation

Location: **Kirklareli / Eskisehir / Turkey**  
Client: **Pasabahce Cam Industry and Trade Inc.**  
Gross Area:  
Project Year: **2014-2015**  
Scope: **Mechanical Engineering Services**



---

## Kirklareli Chocolate and Ice-Cream Products Factory

Location: **Kirklareli - Turkey**  
Client: **Sanset Food & Tourism Industry & Trade Inc. Co. Tokgoz Group**  
Gross Area: **150.000 m<sup>2</sup>**  
Project Year: **2015**  
Scope: **Mechanical Engineering Services**



---

## Kirklareli High Technology Pharmaceutical Factory

Location: **Kirklareli - Turkey**  
Client: **Arven Pharmaceutical Industry & Trade Company and Tokgoz Group**  
Gross Area: **37.000 m<sup>2</sup>**  
Project Year: **2015**  
Scope: **Mechanical Engineering Services**



---

## Elif Plastic Egypt Factory Facility

Location: **Egypt**  
Client: **Elif Plastic Co. Inc.**  
Gross Area: **17.000 m<sup>2</sup>**  
Project Year: **2013**  
Scope: **Mechanical Engineering Services**



---

## Modakon Dyeing Factory

Location: **Cerkezkoy-Tekirdag / Turkey**  
Client:  
Gross Area:  
Project Year: **2012**  
Scope: **Mechanical Engineering Services**

---

---

## MG New Fragrance Factory

Location: **Gebze / Turkey**  
Client: **Alaz Albay Architecture**  
Gross Area: **16.000 m<sup>2</sup>**  
Project Year: **2021**  
Scope: **Mechanical Engineering Services**

---

---

## Toyota Factory Facility

Location: **St Petersburg / Russia**  
Client: **Enka Construction Co. Inc.**  
Gross Area: **57.000 m<sup>2</sup>**  
Project Year: **2006**  
Scope: **Mechanical Engineering Services**





---

## Nissan Car Factory

Location: **St. Petersburg / Russia**  
Client: **Beta Tek Constructions**  
Gross Area: **58.000 m<sup>2</sup>**  
Project Year: **2006**  
Scope: **Mechanical Engineering Services**



---

## Opel Factory Facility

Location: **St. Petersburg / Russia**  
Client: **Enka Construction Co. Inc.**  
Gross Area: **72.000 m<sup>2</sup>**  
Project Year: **2007**  
Scope: **Mechanical Engineering Services**



## Ford Otosan Automotive Factory

Location: **Kocaeli / Turkey**  
Client: **Ford Otosan**  
Gross Area:  
Project Year: **2002**  
Scope: **Fire Fighting Services**



## Modern Carton Paper PM5 Factory Facility

Location: **Corlu-Tekirdag - Turkey**  
Client: **Modern Carton Paper Co. Inc.**  
Gross Area: **35.000 m<sup>2</sup>**  
Project Year: **2013**  
Scope: **Mechanical Engineering Services**





## Modern Carton Paper PM4 Factory Facility

Location: **Corlu-Tekirdag / Turkey**  
Client:  
Gross Area: **21.000 m<sup>2</sup>**  
Project Year: **2012**  
Scope: **Mechanical Engineering Services**



## Kipas Carton Paper Factory Plant

Location: **Kahramanmaras / Turkey**  
Client: **Kipas Kağıt Sanayi İşletmeleri Co. Inc.**  
Gross Area: **50.000 m<sup>2</sup>**  
Project Year: **2012**  
Scope: **Mechanical Engineering Services**





## Kipas Carton Paper Factory Plant

Location: **Aydin-Soke / Turkey**  
Client: **Kipas Kagit Sanayi İşletmeleri Co. Inc.**  
Gross Area: **100.000 m<sup>2</sup>**  
Project Year: **2018**  
Scope: **Mechanical Engineering Services**

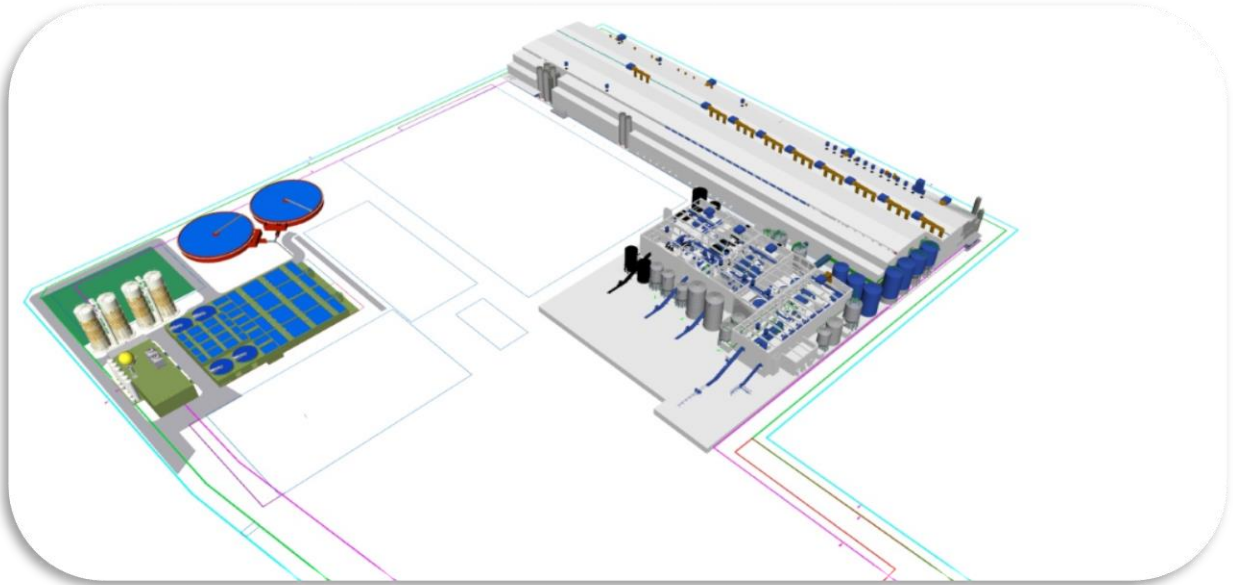

## John Deere Hattat Tractor Factory

Location: **Cerkezkoy-Tekirdag / Turkey**  
Client: **Hattat**  
Gross Area: **20.000 m<sup>2</sup>**  
Project Year: **2006**  
Scope: **Mechanical Engineering Services**



## SDS Kardenim Levi's Jean Design and Production Village

Location: **Beyazkoy-Tekirdag / Turkey**  
Client: **Karamanci Holding Inc.**  
Gross Area: **32.000 m<sup>2</sup>**  
Project Year: **2005**  
Scope: **Mechanical Engineering Services**



---

### Somal Metal Sheet Factory Building

Location: **Kocaeli / Turkey**  
Client: **DB Architecture**  
Gross Area: **10.330 m<sup>2</sup>**  
Project Year: **2005**  
Scope: **Mechanical Engineering Services**



---

### Omsan 21st Century Logistics Base

Location: **Tuzla-Istanbul / Turkey**  
Client: **Omsan Co.**  
Gross Area: **30.000 m<sup>2</sup>**  
Project Year: **2006**  
Scope: **Mechanical Engineering Services**



---

### Novartis Pharmaceutical Site HVAC System Project

Location: **Kurtkoy-Istanbul / Turkey**  
Client: **Tetisan Inc.**  
Gross Area: **40.000 m<sup>2</sup>**  
Project Year: **2004**  
Scope: **Mechanical Engineering Services**



---

### Can Textile Istanbul Factory Facility

Location: **Sisli-Istanbul / Turkey**  
Client: **Can Group**  
Gross Area: **80.000 m<sup>2</sup>**  
Project Year: **2004**  
Scope: **Mechanical Engineering Services**



---

### YKK Zipper, Button and Apparel Production Accessory Factory

Location: **Cerkezkoy-Tekirdag / Turkey**  
Client: **Hazama Corporation**  
Gross Area:  
Project Year: **2003**  
Scope: **Mechanical Engineering Services**

---



---

### Sahinler Holding Free Zone Project (A.S.B)

Location: **Corlu-Tekirdag / Turkey**  
Client: **Sahinler Holding**  
Gross Area:  
Project Year: **2002**  
Scope: **Mechanical Engineering Services**

---



---

### Otoyol – Iveco Central Heating Center

Location: **Arifiye-Adapazari / Turkey**  
Client: **Otoyol Iveco**  
Gross Area:  
Project Year: **2002**  
Scope: **Mechanical Engineering Services**

---



---

### Iveco Training and Service Building

Location: **Kartal-Istanbul / Turkey**  
Client: **Otoyol Iveco**  
Gross Area:  
Project Year: **2002**  
Scope: **Mechanical Engineering Services**

---





### Colin's, Loft Jeans Factory

Location: **Corlu-Tekirdag / Turkey**  
Client: **EROGLU GIYIM SAN. TIC. LTD. CO.**  
Gross Area: **40.000 m<sup>2</sup>**  
Project Year: **2003**  
Scope: **Mechanical Engineering Services**



### Cargill - Turyag Factory (Cooling System Upgrade Project)

Location: **Balikesir / Turkey**  
Client: **Cargill**  
Gross Area:  
Project Year: **2016**  
Scope: **Mechanical Engineering Services**



### Tanriverdi Weaving Apre Dyeing Factory

Location: **Corlu-Tekirdag / Turkey**  
Client:  
Gross Area: **80.000 m<sup>2</sup>**  
Project Year: **2004**  
Scope: **Mechanical Engineering Services**



### Tubitak National Metrology Institute Fluid Mechanics Laboratories

Location: **Gebze-Kocaeli / Turkey**  
Client:  
Gross Area: **25.000 m<sup>2</sup>**  
Project Year: **2004**  
Scope: **Mechanical Engineering Services**



---

### Kutes Metal Cast-Iron Factory

Location: **Corlu-Tekirdag / Turkey**  
Client: **Kutes Metal Sanayi ve Tic. A.Ş.**  
Gross Area: **3.000 m<sup>2</sup>**  
Project Year: **2017**  
Scope: **Mechanical  
Engineering  
Services + Consultancy**



---

### Kibar Holding – Ispak Packing Factory

Location: **Izmit / Turkey**  
Client: **Kibar Group**  
Gross Area: **25.000 m<sup>2</sup>**  
Project Year: **2018**  
Scope: **Consulting Services**



---

### Coca Cola Factory Facility

Location: **Isparta / Turkey**  
Client: **HPP Architecture**  
Gross Area: **14.000 m<sup>2</sup>**  
Project Year: **2014**  
Scope: **Mechanical Engineering Services**



---

### Coca Cola Factory Facility

Location: **Dushanbe / Tajikistan**  
Client: **HPP Architecture**  
Gross Area: **19.054 m<sup>2</sup>**  
Project Year: **2015**  
Scope: **Mechanical Engineering Services**



---

## Superlit GRP Pipe Factory

Location: **Bolu / Turkey**  
Client: **Karamanci Holding**  
Gross Area: **20.000 m<sup>2</sup>**  
Project Year: **2002**  
Scope: **Mechanical Engineering Services**



---

## Frito-Lay Manufacturing Facility

Location: **Moscow / Russia**  
Client: **Enka Construction Co. Inc.**  
Gross Area: **10.000 m<sup>2</sup>**  
Project Year: **2005**  
Scope: **Mechanical Engineering Services**



---

## Suleymaniye Power Plant Project

Location: **Suleymaniye / North Iraq**  
Client: **Enka Construction Inc.**  
Gross Area: **12.000 m<sup>2</sup>**  
Project Year: **2015**  
Scope: **Mechanical Engineering Services**



---

## Erbil Power Plant Project

Location: **Erbil / Iraq**  
Client: **Enka Construction Co. Inc.**  
Gross Area: **12.000 m<sup>2</sup>**  
Project Year: **2015**  
Scope: **Mechanical Engineering Services**





## Istanbul New Airport Celebi Antrepo Cargo Building

Location: **Istanbul / Turkey**  
Client: **Celebi Yer Hizmetleri**  
Gross Area: **26.800 m<sup>2</sup>**  
Project Year: **2017**  
Scope: **Mechanical  
Engineering  
Services**



## Alcoa Cacao Factory

Location: **Plovdiv / Bulgaria**  
Client: **Alcoa Ltd.**  
Gross Area: **18.000 m<sup>2</sup>**  
Project Year: **2016**  
Scope: **Mechanical Engineering Services (%30)**

## Burger King Restaurants

Location: **Istanbul / Turkey**  
Client: **Ekur Co.**  
Gross Area:  
Project Year: **2004-2008**  
Scope: **Mechanical Engineering Services**



## Arby's Restaurants (Burger King Group)

Location: **Istanbul / Turkey**  
Client: **Ekur Co.**  
Gross Area:  
Project Year: **2004-2008**  
Scope: **Mechanical Engineering Services**



---

## Potato Processing Factory Facility (Burger King Group)

Location: **Afyon / Turkey**  
Client: **AtaKey Potato Food Co. Inc.**  
Gross Area: **70.000 m<sup>2</sup>**  
Project Year: **2014**  
Scope: **Mechanical Engineering Services**



---

## Ekmek Unlu Gıda Sanayi ve Ticaret Co. (Burger King Group)

Location: **Bolu / Turkey**  
Client: **Ekur Construction Co.**  
Gross Area: **10.000 m<sup>2</sup>**  
Project Year: **2013**  
Scope: **Mechanical Engineering Services**



---

## Levi's Apparel Production Factory Dyeing – Washing Plant

Location: **Corlu-Tekirdag / Turkey**  
Client: **Levi's**  
Gross Area:  
Project Year: **2002**  
Scope: **Mechanical  
Engineering  
Services**



---

## Almodo Textile Dyeing Factory

Location: **Cerkezkoy-Tekirdag / Turkey**  
Client: **Almoda Tekstil**  
Gross Area:  
Project Year: **2002**  
Scope: **Mechanical  
Engineering  
Services**



## Bosch Rexroth Factory

Location: **Kocaeli / Turkey**  
Client:  
Gross Area: **20.000 m<sup>2</sup>**  
Project Year: **2012**  
Scope: **Mechanical  
Engineering  
Services**



## Inan Makina

Location: **Cerkezkoy-Tekirdag / Turkey**  
Client: **Inan Makina Sanayi ve Tic.**  
Gross Area: **50.000 m<sup>2</sup>**  
Project Year: **2017**  
Scope: **Mechanical  
Engineering  
Services**



## Yukos Technology Center

Location: **Moscow / Russia**  
Client: **Enka Construction Co. Inc.**  
Gross Area: **11.500 m<sup>2</sup>**  
Project Year: **2007**  
Scope: **Mechanical  
Engineering  
Services**



## Assan Orhanli Logistic

Location: **Tuzla / Turkey**  
Client: **With Kibar Holding**  
Gross Area: **46.000 m<sup>2</sup>**  
Project Year: **2018**  
Scope: **Mechanical  
Engineering  
Services**





---

## Systemair-Hsk Air Handling Unit Factory

Location: **Kocaeli / Turkey**  
Client: **Serhan Ceyhan Architecture**  
Gross Area: **25.000 m<sup>2</sup>**  
Project Year: **2017**  
Scope: **Mechanical  
Engineering  
Services**



---

## TUBITAK NATIONAL METROLOGY INSTITUTE FLUID MECHANICS LABORATORIES

Location: **Kocaeli / Turkey**  
Client:  
Gross Area: **25.000 m<sup>2</sup>**  
Project Year: **2001**  
Scope: **Mechanical  
Engineering  
Services**



---

## Mondelez Candy Facility

Location: **Gebze / Turkey**  
Client: **Mondelez**  
Gross Area: **15.000 m<sup>2</sup>**  
Project Year: **2020**  
Scope: **Mechanical  
Engineering  
Services**



---

## EG Logistic

Location: **Moscow / Russia**  
Client: **With Arcad Architectural Co., Ltd.**  
Gross Area: **40.000 m<sup>2</sup>**  
Project Year: **2006**  
Scope: **Mechanical Engineering Services**

---

---

### Uzel Tractor Factory

Location: **Bolu / Turkey**  
Client: **UZEL**  
Gross Area: **165.000 m<sup>2</sup>**  
Project Year: **2006**  
Scope: **Mechanical Engineering Services**

---

---

### Denimko Ecological Agriculture Plant

Location: **Corlu-Tekirdag / Turkey**  
Client: **DENIMKO**  
Gross Area:  
Project Year: **2006**  
Scope: **Mechanical Engineering Services**

---

---

### Kazakhstan Molybdenum Mining Facilities

Location: **Koktenkol / Kazakhstan**  
Client: **Enka Construction Co. Inc.**  
Gross Area: **82.500 m<sup>2</sup>**  
Project Year: **2014**  
Scope: **Tender Document**

---

---

### TANAP Process Piping Project

Location: **Ardahan-Eskisehir-Tekirdag/Turkey**  
Client: **Serhan Ceyhan Architecture**  
Gross Area: **5.700 m<sup>2</sup>**  
Project Year: **2017**  
Scope: **Mechanical Engineering Services**

---

---

### Namet Meat Processing Facility

Location: **Düzce/Turkey**  
Client: **Namet**  
Gross Area: **110.000 m<sup>2</sup>**  
Project Year: **2019**  
Scope: **Mechanical Engineering Services**

---

---

## Kutahya Carton Paper Factory Plant

Location: **Kutahya/Turkey**  
Client: **Namet**  
Gross Area: **80.000 m<sup>2</sup>**  
Project Year: **2019**  
Scope: **Mechanical Engineering Services**

---

---

## Vem Administrative Building

Location: **Kirklareli/Turkey**  
Client: **Vem**  
Gross Area: **16.000 m<sup>2</sup>**  
Project Year: **2021**  
Scope: **Mechanical Engineering Services**

---

---

## Eczacıbaşı İlaç Fabrikası - Zentiva - Sanofi Pal Mal Pharmaceutical Factory

Location: **Kirklareli/Turkey**  
Client: **Sanofi**  
Gross Area: **60.000 m<sup>2</sup>**  
Project Year: **2020**  
Scope: **Mechanical Engineering Services**

---

---

## BIEM Pharmaceutical Factory

Location: **Cerkezkoy/Turkey**  
Client: **Biem İlaç Sanayi Ve Ticaret Aş.**  
Gross Area: **12.000 m<sup>2</sup>**  
Project Year: **2021**  
Scope: **Mechanical Engineering Services**

---

## Residential Building Projects

### Flame Towers – Residential Building

Location: **Baku / Azerbaijan**  
Client: **DIA Holding**  
Gross Area: **230.000 m<sup>2</sup>**  
Project Year: **2012**  
Scope: **Mechanical  
Engineering  
Services**

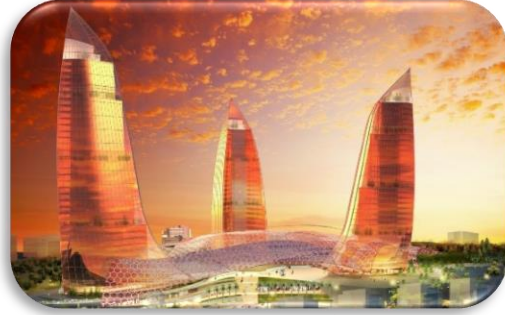

### Kartal Manzara Adalar Residence and Office Project

Location: **Kartal-Istanbul / Turkey**  
Client: **IS Real Estate Investment Trust**  
Gross Area: **315.000 m<sup>2</sup>**  
Project Year: **2016**  
Scope: **Mechanical  
Engineering  
Services**



### Yoo Istanbul

Location: **Besiktas-Istanbul / Turkey**  
Client: **Say Construction Inc.**  
Gross Area: **50.000 m<sup>2</sup>**  
Project Year: **2016**  
Scope: **Mechanical  
Engineering  
Services**



### Nurol Life Aslantepi Project

Location: **Seyrantepe-Istanbul / Turkey**  
Client: **Vizyon Asya – Hakan Kiran  
Architecture**  
Gross Area: **132.000 m<sup>2</sup>**  
Project Year: **2016**  
Scope: **Mechanical  
Engineering  
Services**





---

### G-Yoo Residence Project

Location: **Bagcilar-Istanbul / Turkey**  
Client: **Mar Yapi Construction Inc.**  
Gross Area: **93.360 m<sup>2</sup>**  
Project Year: **2016**  
Scope: **Mechanical  
Engineering  
Services**



---

### Tri – G Rotana Residence Project

Location: **Bagcilar-Istanbul / Turkey**  
Client: **Mar Yapi Construction Inc.**  
Gross Area: **45.000 m<sup>2</sup>**  
Project Year: **2016**  
Scope: **Mechanical  
Engineering  
Services**



---

### G Tower Residence Project

Location: **Gunesli-Istanbul / Turkey**  
Client: **Mar Yapi Construction Inc.**  
Gross Area: **66.000 m<sup>2</sup>**  
Project Year: **2015**  
Scope: **Mechanical  
Engineering  
Services**



---

### Avrupark Hayat Residence Project

Location: **Esenyurt-Istanbul / Turkey**  
Client: **Cihan İnfaat Co.**  
Gross Area: **250.000 m<sup>2</sup>**  
Project Year: **2017**  
Scope: **Mechanical  
Engineering  
Services**



---

### NEF Kandilli Residence Project

Location: **Istanbul / Turkey**  
Client: **NEF**  
Gross Area: **135.000 m<sup>2</sup>**  
Project Year: **2017**  
Scope: **Mechanical  
Engineering  
Services**



---

### NEF Sutluce Residence Project

Location: **Istanbul / Turkey**  
Client: **NEF**  
Gross Area: **16.000 m<sup>2</sup>**  
Project Year: **2017**  
Scope: **Mechanical  
Engineering  
Services**



---

### Eroglu Hotel – Residence Building

Location: **Merter-Istanbul / Turkey**  
Client: **Eroglu Yapi Co.**  
Gross Area: **128.208 m<sup>2</sup>**  
Project Year: **2013**  
Scope: **Mechanical  
Engineering  
Services**



---

### Inistanbul Residence

Location: **Topkapi-Istanbul / Turkey**  
Client: **IS GYO - NEF**  
Gross Area: **351.000 m<sup>2</sup>**  
Project Year: **2016**  
Scope: **Mechanical  
Engineering  
Services  
(Mechanical Rooms  
Designed with Revit.)**



## Nivo Istanbul

Location: **Gunesli-Istanbul / Turkey**  
Client: **Dome + Partners**  
Gross Area: **180.000 m<sup>2</sup>**  
Project Year: **2016**  
Scope: **Mechanical  
Engineering  
Services**



## Bahcesehir Park Residence Project

Location: **Istanbul / Turkey**  
Client: **ATMACA**  
Gross Area: **130.400 m<sup>2</sup>**  
Project Year: **2018**  
Scope: **Mechanical  
Engineering  
Services**



## Eroglu Residence Building

Location: **Halkali-Istanbul / Turkey**  
Client: **Eroglu Yapi Co.**  
Gross Area: **131.988 m<sup>2</sup>**  
Project Year: **2012**  
Scope: **Mechanical  
Engineering  
Services**



## AND Pastel Kartal Project

Location: **Kartal-Istanbul / Turkey**  
Client: **Anadolu Gayrimenkul**  
Gross Area: **285.000 m<sup>2</sup>**  
Project Year: **2016**  
Scope: **Mechanical  
Engineering  
Services**





---

### The Mandarins Acibadem Residence

Location: **Acibadem-Istanbul / Turkey**  
Client: **Selka NSK - Proplan Inc.**  
Gross Area: **90.000 m<sup>2</sup>**  
Project Year: **2016**  
Scope: **Mechanical  
Engineering  
Services**



---

### Cebeci Pendik Residence Project

Location: **Pendik-Istanbul / Turkey**  
Client: **Cebeci Construction**  
Gross Area: **34.500 m<sup>2</sup>**  
Project Year: **2016**  
Scope: **Mechanical  
Engineering  
Services**



---

### Basyapit Dragos Konut Projesi

Location: **Maltepe-Istanbul / Turkey**  
Client: **Mabco Construction Inc.**  
Gross Area: **27.500 m<sup>2</sup>**  
Project Year: **2015**  
Scope: **Mechanical  
Engineering  
Services**



---

### 1 Coastal City

Location: **Buyukcekmece-Istanbul / Turkey**  
Client: **Ozyurtlar Construction Inc.**  
Gross Area: **47.132 m<sup>2</sup>**  
Project Year: **2016**  
Scope: **Mechanical  
Engineering  
Services**





### N-Logo Residence Project

Location: **Esenyurt-Istanbul / Turkey**  
Client: **Ozyurtlar Construction Inc.**  
Gross Area: **308.987 m<sup>2</sup>**  
Project Year: **2016**  
Scope: **Mechanical Engineering Services**



### Meydan Ardıçlı Residence Project

Location: **Esenyurt-Istanbul / Turkey**  
Client: **Ozyurtlar Construction Inc.**  
Gross Area: **250.000 m<sup>2</sup>**  
Project Year: **2017**  
Scope: **Mechanical Engineering Services**



### 3S Firuze Konakları

Location: **Avcılar-Istanbul / Turkey**  
Client: **3S Kale Gayrimenkul Gelistirme ve Yatirim Inc.**  
Gross Area: **95.000 m<sup>2</sup>**  
Project Year: **2016**  
Scope: **Mechanical Engineering Services**



### 3S Kale Zeytinburnu Project

Location: **Zeytinburnu-Istanbul / Turkey**  
Client: **3S Kale Gayrimenkul Gelistirme ve Yatirim Inc.**  
Gross Area: **53.700 m<sup>2</sup>**  
Project Year: **2017**  
Scope: **Mechanical Engineering Services**



### Ncadde Ates Corner

Location: **Esenyurt-Istanbul / Turkey**  
Client: **Ozyurtlar Construction Inc.**  
Gross Area: **27.560 m<sup>2</sup>**  
Project Year: **2017**  
Scope: **Mechanical  
Engineering  
Services**



### Polat Tower Residence

Location: **Sisli-Istanbul / Turkey**  
Client: **Polat Construction Co**  
Gross Area: **80.000 m<sup>2</sup>**  
Project Year: **1999**  
Scope: **Mechanical  
Engineering  
Services**



### Kelesoglu Deniz Istanbul Residence Project (3 Phase)

Location: **Istanbul / Turkey**  
Client: **Kelesoglu Construction Inc.**  
Gross Area: **170.000 m<sup>2</sup>**  
Project Year: **2018**  
Scope: **Mechanical Engineering Services**



### Albayrak TV Studio - Office - Residence Project

Location: **Istanbul / Turkey**  
Client: **Albayrak Construction**  
Gross Area: **185.000 m<sup>2</sup>**  
Project Year: **2013**  
Scope: **Mechanical  
Engineering  
Services (30 %)**



### Mesa Cubuklu 28 Residence Project

Location: **Beykoz-Istanbul / Turkey**  
Client: **Mesa Mesken Sanayii A.Ş**  
Gross Area: **25.000 m<sup>2</sup>**  
Project Year: **2017**  
Scope: **Mechanical  
Engineering  
Services**



### Mesa Cadde Residence Project

Location: **Beykoz-Istanbul / Turkey**  
Client: **Mesa Mesken Sanayii A.Ş**  
Gross Area: **80.000 m<sup>2</sup>**  
Project Year: **2017**  
Scope: **Mechanical  
Engineering  
Services**



### Mesa 10 Orman Residence Project

Location: **Beykoz-Istanbul / Turkey**  
Client: **Mesa Mesken Sanayii A.Ş**  
Gross Area: **7.000 m<sup>2</sup>**  
Project Year: **2017**  
Scope: **Mechanical  
Engineering  
Services**



### Mesa 11 Orman Residence Project

Location: **Beykoz-Istanbul / Turkey**  
Client: **Mesa Mesken Sanayii A.Ş**  
Gross Area: **48.000 m<sup>2</sup>**  
Project Year: **2017**  
Scope: **Mechanical  
Engineering  
Services**





### Cebeci Kurtkoy Project

Location: **Kurtkoy-Istanbul / Turkey**  
Client: **Cebeci GYO**  
Gross Area: **25.000 m<sup>2</sup>**  
Project Year: **2018**  
Scope: **Mechanical  
Engineering  
Services**



### Cintemani Istanbul

Location: **Seyrantepe-Istanbul / Turkey**  
Client: **Hakan Kiran Architectural And  
Construction Services Ltd. Co.**  
Gross Area: **180.967 m<sup>2</sup>**  
Project Year: **2012**  
Scope: **Mechanical  
Engineering  
Services (20%)**



### Sariyer Panorama Koc Life Residence

Location: **Sariyer-Istanbul / Turkey**  
Client: **Kilicoglu Group & Delta Co.**  
Gross Area: **25.000 m<sup>2</sup>**  
Project Year: **2008**  
Scope: **Mechanical  
Engineering  
Services**



### Nidapark Besiktas Residence Project

Location: **Besiktas-Istanbul / Turkey**  
Client: **Tahincioglu Holding**  
Gross Area: **6.200 m<sup>2</sup>**  
Project Year: **2013**  
Scope: **Mechanical  
Engineering  
Services**





---

## Green Valley French Palace and Villas

Location: **Baku / Azerbaijan**  
Client: **DIA Holding FZCO**  
Gross Area: **79.750 m<sup>2</sup>**  
Project Year: **2014**  
Scope: **Mechanical  
Engineering  
Services**



---

## Rublevo Residence Project

Location: **Moscow / Russia**  
Client: **Ant Construction Co. Inc.**  
Gross Area: **108.438 m<sup>2</sup>**  
Project Year: **2015**  
Scope: **Mechanical  
Engineering  
Services**



---

## Pasakoy Residence

Location: **Istanbul / Turkey**  
Client: **Yapi Merkezi**  
Gross Area: **100.000 m<sup>2</sup>**  
Project Year: **2018**  
Scope: **Mechanical  
Engineering  
Services**



---

## Kelesoglu Fikirtepe Residence Project

Location: **Istanbul / Turkey**  
Client: **Kelesoglu Construction Inc.**  
Gross Area: **62.000 m<sup>2</sup>**  
Project Year: **2016**  
Scope: **Mechanical  
Engineering  
Services**



---

## Batumi Riviera Residence

Location: **Batumi / Georgia**  
Client: **Silkroad LLC**  
Gross Area: **65.000 m<sup>2</sup>**  
Capacity:  
Project Year: **2019**  
Scope: **Mechanical  
Engineering  
Services**



---

## Mtsvane Kontskhi Resort & SPA (Green Cape Hotel)

Location: **Batumi / Georgia**  
Client: **GTDF - LLC**  
Gross Area: **38.000 m<sup>2</sup>**  
Capacity:  
Project Year: **2018**  
Scope: **Mechanical  
Engineering  
Services**



---

## Sololaki Rise Hotel and Residence

Location: **Tbilisi / Georgia**  
Client: **GTDF - LLC**  
Gross Area: **180.000 m<sup>2</sup>**  
Capacity:  
Project Year: **2019**  
Scope: **Mechanical  
Engineering  
Services**



---

## Resadiye Villas

Location: **Istanbul / Turkey**  
Client: **Ergun Mimarlik**  
Gross Area: **2.650 m<sup>2</sup>**  
Capacity:  
Project Year: **2020**  
Scope: **Mechanical  
Engineering  
Services**

---

---

## Acarkent C-27 And C -28 Villages

Location: **Beykoz-Istanbul / Turkey**  
Client:  
Gross Area: **2 x 500 m<sup>2</sup>**  
Project Year: **2002**  
Scope: **Mechanical Engineering Services**

---

---

## Mandarins 2 Residence

Location: **Istanbul / Turkey**  
Client: **Mandarins Co**  
Gross Area: **90.000 m<sup>2</sup>**  
Project Year: **2018**  
Scope: **Mechanical Engineering Services (Hold)**

---

---

## Polat Residence

Location: **Caddebostan-Istanbul / Turkey**  
Client: **Polat Construction Co**  
Gross Area: **8.000 m<sup>2</sup>**  
Project Year: **2013**  
Scope: **Mechanical Engineering Services**

---

---

## Mesa Antalya Residence Project

Location: **Antalya / Turkey**  
Client: **Mesa Mesken Sanayii A.Ş**  
Gross Area: **180.000 m<sup>2</sup>**  
Project Year: **2018**  
Scope: **Mechanical  
Engineering  
Services**

---



---

## NEF Gaziosmanpasa Residence Project

Location: **Istanbul / Turkey**  
Client: **NEF**  
Gross Area: **220.000 m<sup>2</sup>**  
Project Year: **2018**  
Scope: **Mechanical Engineering Services**

---

---

## Cebeci Bodrum Villas

Location: **Mugla / Turkey**  
Client: **Cebeci Construction**  
Gross Area: **5.000 m<sup>2</sup>**  
Project Year: **2018**  
Scope: **Mechanical Engineering Services**

---

---

## Kutuzovsky Residence

Location: **Moscow / Russia**  
Client:  
Gross Area: **37.000 m<sup>2</sup>**  
Project Year: **2013**  
Scope: **Mechanical  
Engineering  
Services**

---

## Cultural and Educational Building Projects

### **Leonardo Da Vinci Compress Project Fair Center and Museum**

Location: **Sutluce-Istanbul / Turkey**  
Client: **Hakan Kiran Architecture**  
Gross Area: **65.130 m<sup>2</sup>**  
Project Year: **2017**  
Scope : **Mechanical  
Engineering  
Services (30%)**



### **Mimar Sinan Fine Arts University Museum of Contemporary Art Warehouse Project**

Location: **Beyoglu - Istanbul / Turkey**  
Client: **Emre Arolat Architecture**  
Gross Area: **18.000 m<sup>2</sup>**  
Project Year: **2015**  
Scope: **Mechanical  
Engineering  
Services**



### **Bilgi University Santral Istanbul Campus**

Location: **Eyup - Istanbul / Turkey**  
Client: **Bilgi University**  
Gross Area: **44.000 m<sup>2</sup>**  
Project Year: **2006**  
Scope: **Mechanical  
Engineering  
Services**



### **Istanbul Sehir University**

Location: **Dragos - Istanbul / Turkey**  
Client: **Istanbul Sehir University**  
Gross Area: **70.000 m<sup>2</sup>**  
Project Year: **2015**  
Scope: **Mechanical  
Engineering  
Services**



---

## Koc Contemporary Museum

Location: **Beyoglu - Istanbul / Turkey**  
Client: **Grimshaw - Turgut Alton  
Architecture**  
Gross Area: **16.000 m<sup>2</sup>**  
Project Year: **2017**  
Scope: **Mechanical  
Engineering  
Services**



---

## Yedikule CER Istanbul Historical Buildings and Residence Project

Location: **Yedikule-Istanbul / Turkey**  
Client: **Ege Yapi**  
Gross Area: **40.000 m<sup>2</sup>**  
Project Year: **2017**  
Scope: **Mechanical  
Engineering  
Services**



---

## Alpaslan National Government Theatre Building

Location: **Ashgabat / Turkmenistan**  
Client: **Gap Construction Co.**  
Gross Area: **11.000 m<sup>2</sup>**  
Project Year: **2008**  
Scope: **Mechanical  
Engineering  
Services**



---

## Ertugrul Kurdoglu Primary School

Location: **Arhavi - Artvin / Turkey**  
Client: **Ata Construction**  
Gross Area: **1998**  
Project Year: **1998**  
Scope: **Mechanical  
Engineering  
Services**



---

### **Military School and Civil Defense Buildings**

Location: **Ashgabat / Turkmenistan**  
Client: **Polimeks Construction Co.**  
Gross Area: **75.000 m<sup>2</sup>**  
Project Year: **2007**  
Scope: **Mechanical  
Engineering  
Services**



---

### **Suleyman Sah University Campus**

Location: **Tuzla - Istanbul / Turkey**  
Client: **Dumankaya Construction Inc.**  
Gross Area: **130.000 m<sup>2</sup>**  
Project Year: **2009**  
Scope: **Mechanical  
Engineering  
Services**



---

### **Conference Center Project**

Location: **Gabon / Africa**  
Client: **Enka Construction Co. Inc.**  
Gross Area: **35.000 m<sup>2</sup>**  
Project Year: **2014**  
Scope: **Mechanical  
Engineering  
Services (90%)**



---

### **Pamukkale University Architecture Campus**

Location: **Denizli / Turkey**  
Client: **İTÜ NOVA**  
Gross Area: **18.000 m<sup>2</sup>**  
Project Year: **2017**  
Scope: **Mechanical  
Engineering  
Services**





### Kocaeli Dorm Project

Location: **Kocaeli / Turkey**  
Client: **UNIVA**  
Gross Area: **20.000 m<sup>2</sup>**  
Project Year: **2018**  
Scope: **Mechanical  
Engineering  
Services**



### Duzce Dorm Project

Location: **Duzce / Turkey**  
Client: **UNIVA**  
Gross Area: **50.000 m<sup>2</sup>**  
Project Year: **2018**  
Scope: **Mechanical  
Engineering  
Services**



### Salekhard Concert Building

Location: **Russia**  
Client: **Yamata Yatirim Co.**  
Gross Area: **10.000 m<sup>2</sup>**  
Project Year: **2008**  
Scope: **Mechanical  
Engineering  
Services**



### Ata Film Studios

Location: **Ayazaga-Istanbul / Turkey**  
Client: **Ata Film Inc.**  
Gross Area: **4.500 m<sup>2</sup>**  
Project Year: **2002**  
Scope: **Mechanical  
Engineering  
Services**



## IPKB Schools Stage-1

Location: **Istanbul / Turkey**  
 Client: **Optimal Project Management**  
 Project Year: **2017**



Murat Beyaz Primary School:	4.743 m <sup>2</sup>
Sair Mehmet Emin Yurdakul Religious School (İHL):	5.000 m <sup>2</sup>
Bostanci Primary School:	7.160 m <sup>2</sup>
Erenkoy Kiz Anatolia High School:	8.115 m <sup>2</sup>
Feneryolu Praticce Art School for Girls:	3.792 m <sup>2</sup>
Nurettin Teksan Middle School:	7.362 m <sup>2</sup>
Maltepe Hulya Oguz Nursey School:	1.309 m <sup>2</sup>
Tev Abdullah Nezahat Erboz Primary School:	4.442 m <sup>2</sup>
Mahir Iz Primary School and Middle School:	8.252 m <sup>2</sup>
Rotary Vakfi Isitme Engelliler Deaf Disabled School:	8.472 m <sup>2</sup>
Bahcelievler Primary School:	6.557 m <sup>2</sup>
Belma Gude Middle School:	4.434 m <sup>2</sup>
Dilaver Cebeci Primary School:	5.131 m <sup>2</sup>
Kupluce Primary School:	4.205 m <sup>2</sup>
Lutfi Ercin Middle School:	3.724 m <sup>2</sup>

Scope: **Mechanical Engineering Services**

## ITUNOVA Technology A.Ş.

Location: **Sariyer-Istanbul / Turkey**  
 Client: **ITUNOVA**  
 Gross Area: **3.000 m<sup>2</sup>**  
 Project Year: **2018**  
 Scope: **Mechanical Engineering Services  
 With Revit**



## Campus Founders Lab

Location: **Heilbronn/Germany**  
 Client: **Werner Sobek**  
 Gross Area: **6.000 m<sup>2</sup>**  
 Project Year: **2021**  
 Scope: **Mechanical Engineering Services**



---

### **Tokat Bilim Merkezi**

Location: **Tokat / Turkey**  
Client: **Tokat Valiliđi**  
Gross Area: **2.000 m<sup>2</sup>**  
Project Year: **2021**  
Scope: **Mechanical Engineering Services**

---

---

### **Ozyegin University Project**

Location: **Cekmekoy-Istanbul / Turkey**  
Client: **Hakan Kiran Architecture**  
Gross Area: **50.000 m<sup>2</sup>**  
Project Year: **2017**  
Scope: **Mechanical Engineering Services (20%)**

---

---

### **Vehbi Koc Vakfi High School**

Location: **Sivas / Turkey**  
Client:  
Gross Area: **5.000 m<sup>2</sup>**  
Project Year:  
Scope: **Mechanical Engineering Services**

---

---

### **Mevlanakapı Female Dormitory**

Location: **Istanbul / Turkey**  
Client: **Ronesans GYO**  
Gross Area: **9.200 m<sup>2</sup>**  
Project Year: **2018**  
Scope: **Mechanical Engineering Services**

---

---

**MAUSOLEE - MOSQUEE - BIBLIOTHEQUE - MUSEE – GARDE  
ADMINISTRATION / FRANCEVILLE**

Location: **Gabon**  
Client:  
Gross Area: **8.000 m<sup>2</sup>**  
Project Year: **2015**  
Scope: **Mechanical Engineering Services**

---



## Hotel and Holiday Village Projects

### **Fairmont Hotel Baku Flame Towers Project**

Location: **Baku / Azerbaijan**  
Client: **DIA Holding**  
Gross Area: **230.000 m<sup>2</sup>**  
Project Year: **2012**  
Scope: **Mechanical Engineering Services**



### **Wyndham Grand Izmir Ozdilek**

Location: **Inciralti-Izmir / Turkey**  
Client: **Ozdilek Co**  
Gross Area: **35.000 m<sup>2</sup>**  
Project Year: **2003**  
Scope: **Mechanical Engineering Services**



### **Swiss Hotel**

Location: **Cesme / Izmir**  
Client: **Dilek Holding and Miray Const.**  
Gross Area: **75.000 m<sup>2</sup>**  
Project Year: **2018**  
Scope: **Mechanical Engineering Services**



### **Samsun Sheraton Hotel**

Location: **Samsun / Turkey**  
Client: **Tanriverdi**  
Gross Area: **100.000 m<sup>2</sup>**  
Project Year: **2015**  
Scope: **Mechanical Engineering Services**



---

## Cornelia Diamond Holiday Village

Location: **Antalya / Turkey**  
Client: **Diler Holding**  
Gross Area: **200.000 m<sup>2</sup>**  
Capacity: **600 Beds**  
Project Year: **2003**  
Scope: **Mechanical Engineering Services**



---

## Adam & Eve Hotel

Location: **Antalya / Turkey**  
Client: **Kayi Group**  
Gross Area: **95.000 m<sup>2</sup>**  
Project Year: **2005**  
Scope: **Mechanical Engineering Services**



---

## St. Regis Hotel

Location: **Besiktas-Istanbul / Turkey**  
Client: **Demsa Domestic**  
Gross Area: **22.851 m<sup>2</sup>**  
Project Year: **2009**  
Scope: **Mechanical Engineering Services**



---

## Swiss Hotel Congress Center

Location: **Izmir / Turkey**  
Client: **Tahincioglu Holding**  
Gross Area: **30.000 m<sup>2</sup>**  
Project Year: **2004**  
Scope: **Mechanical Engineering Services**



---

## Radisson Blu Hotel

Location: **St. Petersburg / Russia**  
Client: **Ucgen Mechanic Co.**  
Gross Area: **13.000 m<sup>2</sup>**  
Capacity: **300 Rooms**  
Project Year: **2006**  
Scope: **Mechanical  
Engineering  
Services \***



---

## Radisson Blu Hotel

Location: **Kiev / Ukraine**  
Client: **Masterbud**  
Gross Area: **13.000 m<sup>2</sup>**  
Capacity: **255 Rooms**  
Project Year: **2006**  
Scope: **Mechanical  
Engineering  
Services \***



---

## Radisson Blu Hotel

Location: **Sisli-Istanbul / Turkey**  
Client: **Sisli Gayrimenkul Yatirim Co.**  
Gross Area: **50.000 m<sup>2</sup>**  
Capacity: **291 Rooms**  
Project Year: **2008**  
Scope: **Mechanical  
Engineering  
Services \***



---

## Radisson Blu Hotel

Location: **Trabzon / Turkey**  
Client: **Karadeniz Orme Sanayi ve  
Dis Ticaret Inc.**  
Gross Area: **25.760 m<sup>2</sup>**  
Capacity: **162 Rooms**  
Project Year: **2017**  
Scope: **Mechanical  
Engineering  
Services \***





---

## Ceylan Intercontinental Hotel

Location: **Beyoglu-Istanbul / Turkey**  
Client:  
Gross Area:  
Capacity: **390 Rooms**  
Project Year: **1995**  
Scope: **Mechanical Engineering Services**



---

## Robinson Selects Maris Club Hotel

Location: **Marmaris / Turkey**  
Client: **Turkon Holding Co.**  
Gross Area: **35.000 m<sup>2</sup>**  
Project Year: **2005**  
Scope: **Mechanical Engineering Services**



---

## Hotel Sillyum

Location: **Belek-Antalya / Turkey**  
Client:  
Gross Area: **25.000 m<sup>2</sup>**  
Project Year: **1999**  
Scope: **Mechanical Engineering Services**



---

## Riviera Podol Hotel

Location: **Kiev / Ukraine**  
Client: **ARMA Ltd. Co.**  
Gross Area: **6.000 m<sup>2</sup>**  
Project Year: **2003**  
Scope: **Mechanical Engineering Services**





---

### Richmond Hotel and Markiz Pastry

Location: **Beyoglu-Istanbul / Turkey**  
Client:  
Gross Area: **13.000 m<sup>2</sup>**  
Project Year: **2005**  
Scope: **Mechanical Engineering Services**



---

### Renaissance Istanbul Polat Bosphorus Hotel

Location: **Balmumcu-Istanbul / Turkey**  
Client: **MP Construction .Co**  
Gross Area: **35.000 m<sup>2</sup>**  
Project Year: **2011**  
Scope: **Mechanical Engineering Services**



---

### Tecim Hotel

Location: **Kadikoy-Istanbul / Turkey**  
Client: **Is GYO**  
Gross Area: **50.000 m<sup>2</sup>**  
Project Year: **2018**  
Scope: **Mechanical Engineering Services**



---

## Mtsvane Kontskhi Resort & SPA (Green Cape Hotel)

Location: **Batumi / Georgia**  
Client: **GTDF - LLC**  
Gross Area: **38.000 m<sup>2</sup>**  
Project Year: **2018**  
Scope: **Mechanical  
Engineering  
Services**



---

## Hyatt Hotel

Location: **Tbilisi / Georgia**  
Client: **Rustaveli Property LLC**  
Gross Area: **20.000 m<sup>2</sup>**  
Project Year: **2020**  
Scope: **Mechanical  
Engineering  
Services**



---

## Sololaki Rise Hotel and Residence

Location: **Tbilisi / Georgia**  
Client: **GTDF - LLC**  
Gross Area: **180.000 m<sup>2</sup>**  
Project Year: **2019**  
Scope: **Mechanical  
Engineering  
Services**



---

## Telavi Hotel

Location: **Telavi / Georgia**  
Client: **M<sup>2</sup> Real Estate LLC**  
Gross Area: **15.000 m<sup>2</sup>**  
Project Year: **2019**  
Scope: **Mechanical  
Engineering  
Services**



---

### Akhasheni Hotel

Location: **Akhasheni / Georgia**  
Client: **M<sup>2</sup> Real Estate LLC**  
Gross Area: **12.000 m<sup>2</sup>**  
Project Year: **2019**  
Scope: **Mechanical Engineering Services**

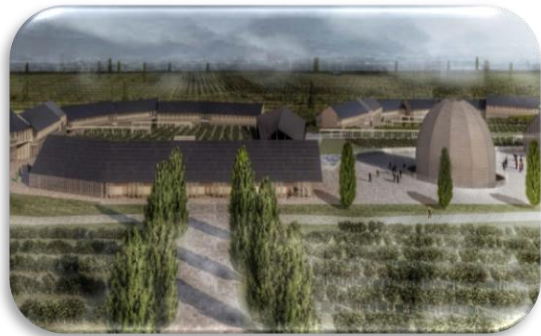

---

### Radisson Collection Telegraph Hotel

Location: **Tbilisi / Georgia**  
Client: **Silk Road**  
Gross Area: **24.000 m<sup>2</sup>**  
Project Year: **2021**  
Scope: **Mechanical Engineering Services**



---

### Cubic Tower

Location: **Batumi / Georgia**  
Client: **Cube Ltd.**  
Gross Area: **70.000 m<sup>2</sup>**  
Project Year: **2021**  
Scope: **Mechanical Engineering Services**



---

### Baden Baden Hotel

Location: **Stuttgart / Germany**  
Client:  
Gross Area: **14.000 m<sup>2</sup>**  
Project Year: **2019**  
Scope: **Mechanical Engineering Services**  
**Completion Ratio: 70%**  
**Waiting for 2<sup>nd</sup> start**





---

## Bukhara Hotel

Location: **Uzbekistan**  
Client: **Group Company AKFA**  
Gross Area: **23.000 m<sup>2</sup>**  
Project Year: **2019**  
Scope: **Mechanical Engineering Services**



---

## Four Seasons Bosphorus Hotel Development and Renovation Project

Location: **Besiktas-Istanbul / Turkey**  
Client: **Atikpasha Turizm Co.**  
Gross Area: **4.000 m<sup>2</sup>**  
Project Year: **2013**  
Scope: **Mechanical Engineering Services**



---

## Conrad Hotel Refurbishment Project Stage-1,2 Millennium Business Center and Roof Bars Renovation Project

Location: **Besiktas-Istanbul / Turkey**  
Client: **Red Engineering**  
Gross Area: **15.000 m<sup>2</sup>**  
Project Year: **2007**  
Scope: **Mechanical Engineering Services**



---

## Anadolu Health Center Companion Hotel

Location: **Gebze-Istanbul / Turkey**  
Client: **Has Architectural Ltd.**  
Gross Area: **12.000 m<sup>2</sup>**  
Project Year: **2006**  
Scope: **Mechanical Engineering Services**





---

### Pera Palas Hotel

Location: **Tepebasi-Istanbul / Turkey**  
Client: **Kalkavan Group  
Besiktas Deniz  
Ve Turizm Yatirimlari Sanayii  
ve Ticaret Co.**  
Gross Area: **11.000 m<sup>2</sup>**  
Project Year: **2010**  
Scope: **Mechanical  
Engineering  
Services**



---

### Mirada Del Lago Hotel

Location: **Erciyes / Turkey**  
Client: **AKSA**  
Gross Area: **30.000m<sup>2</sup>**  
Project Year: **2005**  
Scope: **Mechanical  
Engineering  
Services**



---

### Vienna Burggasse Hotel

Location: **Vienna / Austria**  
Client: **Sembol Construction Co**  
Gross Area: **14.000 m<sup>2</sup>**  
Project Year: **2007**  
Scope: **Mechanical  
Engineering  
Services**



---

## Intercontinental Hotel

Location: **Kiev / Ukraine**  
Client: **Sembol Construction Co**  
Gross Area: **25.000 m<sup>2</sup>**  
Project Year: **2011**  
Scope: **Mechanical  
Engineering  
Services**



---

## AJWA Hotel and Cultural Buildings Projects

Location: **Kapadokya-Nevsehir / Turkey**  
Client: **Gulab Architecture**  
Gross Area: **13.840 m<sup>2</sup>**  
Project Year: **2017**  
Scope: **Mechanical  
Engineering  
Services**

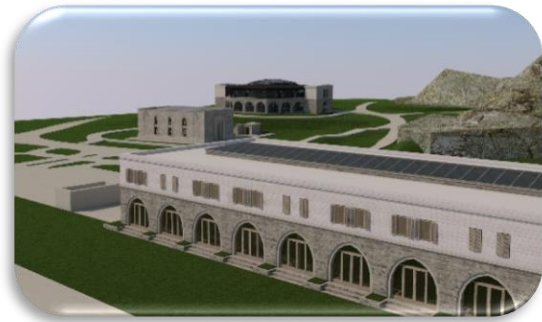

---

## Kale Hotel

Location: **Kapadokya-Nevsehir / Turkey**  
Client: **Gulab Architecture**  
Gross Area: **2.300 m<sup>2</sup>**  
Project Year: **2017**  
Scope: **Mechanical Engineering Services**



---

## AJWA Hotel

Location: **Baku / Azerbaijan**  
Client: **Gulab Architecture**  
Gross Area: **4.473 m<sup>2</sup>**  
Project Year: **2017**  
Scope: **Mechanical Engineering Services**

---

---

### **Balsoya Jitomirskaya Hotel**

Location: **Kiev / Ukraine**  
Client: **ARMA Ltd. Co.**  
Gross Area: **30.000 m<sup>2</sup>**  
Project Year: **2005**  
Scope: **Mechanical Engineering Services**

---

---

### **Bayindir Holding Tourism Center**

Location: **Antalya / Turkey**  
Client: **Bayindir Holding**  
Gross Area: **40.000 m<sup>2</sup>**  
Project Year: **2002**  
Scope: **Mechanical Engineering Services**

---

---

### **Peska Villa Project**

Location: **Bodrum / Turkey**  
Client: **Kalfa Enerji Sistemleri ve İnşaat San. Tic. Ltd. Şti.**  
Gross Area: **9.800 m<sup>2</sup>**  
Project Year: **2014**  
Scope: **Mechanical Engineering Services**

---

---

### **Gasprom Sochi Hotels**

Location: **Sochi / Russia**  
Client: **Haznedaroglu Inc.**  
Gross Area: **50.000 m<sup>2</sup>**  
Project Year: **2006**  
Scope: **Mechanical Engineering Services**

---

---

## Marina Villa Project

Location: **Istanbul / Turkey**  
Client: **Kelesoglu Construction Inc.**  
Gross Area: **30.000 m<sup>2</sup>**  
Capacity:  
Project Year: **2016**  
Scope: **Mechanical Engineering Services**

---

---

## Diler Holding Bodrum Holiday Village

Location: **Bodrum / Turkey**  
Client:  
Gross Area:  
Capacity: **2000 Beds**  
Project Year: **2002**  
Scope: **Mechanical Engineering Services**

---

---

## Aldiana Sarigerme Hotel Renovation Project

Location: **Fethiye-Mugla / Turkey**  
Client:  
Gross Area: **40.000 m<sup>2</sup>**  
Capacity:  
Project Year: **2008**  
Scope: **Mechanical Engineering Services**

---

---

## The Marmara Hotel Refurbishment Project

Location: **Istanbul / Turkey**  
Client:  
Gross Area: **60.000 m<sup>2</sup>**  
Capacity:  
Project Year: **2015**  
Scope: **Renovation Report**

---





## Stadium and Sport Complexes

---

### Istanbul Olympic Stadium

Location: **Istanbul / Turkey**  
Client: **A joint Venture Project Between  
Campenon Bernard SGE  
and Tekfen / SAE International**  
Gross Area:  
Capacity: **80.000 seats**  
Project Year: **1998**  
Scope: **Mechanical Engineering Services**



---

### FC Shakhtar Stadium

Location: **Donesk / Ukraine**  
Client: **Enka Construction Co. Inc**  
Gross Area: **90.000 m<sup>2</sup>**  
Capacity: **50.000 seats**  
Project Year: **2008**  
Scope: **Mechanical Engineering Services**



---

### Astana Olympic Stadium

Location: **Astana / Kazakhstan**  
Client: **Sembol Construction Co.**  
Gross Area: **30.000 m<sup>2</sup>**  
Capacity: **30.000 seats**  
Project Year: **2007**  
Scope: **Mechanical Engineering Services**

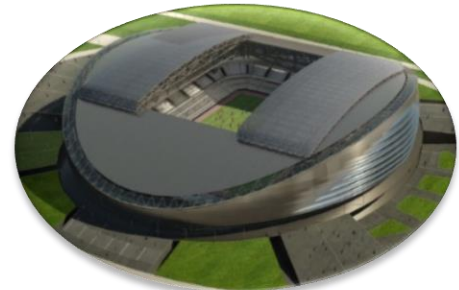

---

### Olympic Swimming Pool Center

Location: **Ashgabat / Turkmenistan**  
Client:  
Gross Area: **30.000 m<sup>2</sup>**  
Capacity:  
Project Year: **2004**  
Scope: **Mechanical Engineering Services**



## CO – Generation & Power Plants

### Can Textile Factory Can Energy Co

Location: **Corlu-Tekirdag / Turkey**  
 Client: **Can Group**  
 Capacity:

<b>6 MW</b>	<b>Co-Gen System (with gas turbine)</b>
<b>4 MW</b>	<b>Co-Gen System (with gas turbine)</b>
<b>100 m<sup>3</sup>/m</b>	<b>Compressed Air System (with gas motor)</b>
<b>30 m<sup>3</sup>/m</b>	<b>Compressed Air System (with steam motor)</b>
<b>60 MW</b>	<b>Co-Gen System (with gas turbine)</b>



Project Year: **2004**  
 Scope: **Mechanical Engineering Services**

### Tanriverdi Weaving, Apre, Dyeing Factory

Location: **Corlu-Tekirdag / Turkey**  
 Client: **Tanriverdi Co.**  
 Gross Area:  
 Capacity: **5 MW Co-Gen System (with gas motors)**

Project Year:  
 Scope: **Mechanical Engineering Services**



### Altinmarka Cacao and Chocolate Factories

Location: **Hadimkoy-Istanbul / Turkey**  
 Client: **Detay Gida San. ve Tic. Inc.**  
 Gross Area:  
 Capacity:

<b>4 MW</b>	<b>Co-Gen System (with gas motors)</b>
<b>9 MW</b>	<b>Co-Gen System (with gas motors)</b>

Project Year:  
 Scope: **Mechanical Engineering Services**

---

## Ceylan Intercontinental Hotel

Location: **Beyoglu-Istanbul / Turkey**  
Client:  
Gross Area:  
Capacity:  
Project Year: **1995**  
Scope: **Mechanical Engineering Services**



---

## Conrad Hotel Refurbishment Project Stage-1,2 Millennium Business Center and Roof Bars Renovation Project

Location: **Besiktas-Istanbul / Turkey**  
Client: **Red Engineering**  
Gross Area: **15.000 m<sup>2</sup>**  
Capacity:  
Project Year: **2007**  
Scope: **Mechanical  
Engineering  
Services**



---

## Yalinkaya Energy Co. (At project developing phase)

Location: **Corlu-Tekirdag / Turkey**  
Client:  
Gross Area:  
Capacity: **400 MW (Gas turbine or gas motor plants)  
(Wind turbine plants)  
(Water turbine plans)**  
Project Year:  
Scope: **Mechanical Engineering Services**

---

## Korozo Istanbul Hadimkoy And Avcilar Factories

Location: **Hadimkoy-Istanbul / Turkey**  
Client:  
Gross Area:  
Capacity: **5 MW Three-Gen System**  
Project Year:  
Scope: **Mechanical Engineering Services**

---



## Some of Building with Yamata Inc.

---

Location: **Russia**

Project Name:

**Muji Service Center**  
**Muji Housing**  
**Pathology Building**  
**Dental Building**  
**Anadyr Tuberculosis Dispensary**  
**Administration Building**  
**Directorate of Ministry Building**  
**Yarsele Housing**  
**Dermatology Building**  
**Government Tax Office Building**  
**Arbitrage Building**  
**Salekhard Business Center**  
**Beloyarsk Hostel Building**  
**Maternity Hospital**  
**Maternity Hospital Catering Building**  
**Salekhard Villa Building**  
**Tyumen Villa Building**  
**Tyumen Church Building**  
**Salekhard Sauna Building**  
**Salekhard Administration Building**  
**Sibir sanatorium building**  
**Salekhard Concert Building**  
**Tarco-Sale Dormitory Building**  
**Novurengoy Trade Center**  
**Sadko Children Rehabilitation Center + Garage**  
**Limited Company Shopping Mall**

---

## CURRENT PROJECTS

<u>PROJECT NAME</u> (DINAMIK PROJE)	<u>AREA</u>	<u>COMPLETION RATIO</u>
✓ Koc Contemporary Museum:	16.000 m <sup>2</sup>	Site Cons.
✓ 3S Kale Zeytinburnu:	53.700 m <sup>2</sup>	50%
✓ Assan Logistic Warehouse:	46.000 m <sup>2</sup>	30% (Hold)
✓ Swiss Cesme Hotel:	75.000 m <sup>2</sup>	30%
✓ Kipas Soke Carton Paper Factory Plant:	100.000 m <sup>2</sup>	50% (Hold)
✓ Green Cape Hotel and Residence Georgia:	38.000 m <sup>2</sup>	50% (Hold)
✓ Telavi Hotel Georgia:	15.000 m <sup>2</sup>	30%
✓ Akhasheni Hotel Georgia:	12.000 m <sup>2</sup>	30%
✓ Sololaki Rise Hotel & Residences Georgia:	180.000 m <sup>2</sup>	50%
✓ Namet Meat Processing Facility Project:	110.000 m <sup>2</sup>	5%
✓ Kutahya Carton Paper Factory Plant:	80.000 m <sup>2</sup>	10%
✓ Bandaranaike International Airport	200.000 m <sup>2</sup>	30%
✓ Radisson Blu Collection Telegraph Hotel:	24.000 m <sup>2</sup>	10%
✓ Cubic Tower:	70.000 m <sup>2</sup>	10%
✓ BIEM Pharmaceutical Factory:	12.000 m <sup>2</sup>	10%

**(DINAMİK PROJE ENERJİ)**

✓ Baku AJWA Hotel:	4.475 m <sup>2</sup>	90%
✓ AJWA Cappadocia Hotel and Cultural Buildings Projects:	13.840 m <sup>2</sup>	90%
✓ Atmaca Bahcesehir Park Residence:	130.400 m <sup>2</sup>	50%
✓ Is GYO Tecim Hotel:	50.000 m <sup>2</sup>	90%
✓ Kale Ayazağa Office :	10.000 m <sup>2</sup>	50%
✓ Baden Baden Hotel Germany:	14.000 m <sup>2</sup>	50%

**(SİNERJİ DİNAMİK PROJE)**

✓ Mesa Antalya Mixed Used Project:	180.000 m <sup>2</sup>	5% (Hold)
✓ Mesa Orman Residence Project:	55.000 m <sup>2</sup>	95%
✓ Kalyon Cavusdere Mixed Used Project:	123.000 m <sup>2</sup>	95%
✓ Istanbul New Airport THY Lounges:	20.000 m <sup>2</sup>	80%
✓ Engelsiz Yaşam Merkezi:	5.000 m <sup>2</sup>	90%
✓ Yapi Merkezi Pasakoy Residence:	100.000 m <sup>2</sup>	60% (Hold)
✓ Hisar Intercontinental Hospital:	65.000 m <sup>2</sup>	5% (Hold)

**(VEKTOR DİNAMİK PROJE)**

✓ Nidapark Kucukyali Office Buildings:	360.000 m <sup>2</sup>	90%
✓ Nidapark Kucukyali Residence Buildings:	360.000 m <sup>2</sup>	70%
✓ Nidapark Cengelkoy Residence Project:	70.000 m <sup>2</sup>	40% (Hold)
✓ Nidapark Maltepe Municipality Project:	30.000 m <sup>2</sup>	30% (Hold)
✓ NEF Kandilli Residence Project:	135.000 m <sup>2</sup>	70%
✓ NEF Gaziosmanpasa Residence Project:	220.000 m <sup>2</sup>	10%
✓ Yesilkoy Suryani Church:	4.700 m <sup>2</sup>	80%
✓ Selway Outlet:	100.000 m <sup>2</sup>	80%
✓ Keleşoğlu Fikirtepe Residence:	62.000 m <sup>2</sup>	50% (Hold)
✓ Waterfall Hotel Georgia:	16.000 m <sup>2</sup>	60%
✓ Bukhara Hotel Uzbekistan:	23.000 m <sup>2</sup>	20%
✓ Kocaeli Dorm Project:	20.000 m <sup>2</sup>	50%
✓ Duzce Dorm Project:	50.000 m <sup>2</sup>	50%
✓ Camlica Residence Project:	300.000 m <sup>2</sup>	30%

**Grand Total Area: 3.868.315 m<sup>2</sup>**

## CONTACT US



Merkez Mah. Koca Mansur Sok.  
Sevimli İş Merkezi. No:39 Kat:1 D:4-5-6  
34381 Şişli / İstanbul



[dinamiks@dinamikproje.com](mailto:dinamiks@dinamikproje.com)



[www.dinamikproje.com](http://www.dinamikproje.com)



phone: 0 (212) 230 30 37  
fax : 0 (212) 247 78 04